

Write your name here

Surname

Other names

Centre Number

Candidate Number

**Pearson Edexcel**  
**Level 1/Level 2 GCSE (9–1)**

# Mathematics

## Paper 2 (Calculator)

**Higher Tier**

Monday 6 November 2017 – Morning  
**Time: 1 hour 30 minutes**

Paper Reference  
**1MA1/2H**

**You must have:** Ruler graduated in centimetres and millimetres, protractor, pair of compasses, pen, HB pencil, eraser, calculator. Tracing paper may be used.

Total Marks

### Instructions

- Use **black** ink or ball-point pen.
- **Fill in the boxes** at the top of this page with your name, centre number and candidate number.
- Answer **all** questions.
- Answer the questions in the spaces provided – *there may be more space than you need.*
- You must **show all your working.**
- Diagrams are **NOT** accurately drawn, unless otherwise indicated.
- **Calculators may be used.**
- If your calculator does not have a  $\pi$  button, take the value of  $\pi$  to be 3.142 unless the question instructs otherwise.



### Information

- The total mark for this paper is 80
- The marks for **each** question are shown in brackets – *use this as a guide as to how much time to spend on each question.*

### Advice

- Read each question carefully before you start to answer it.
- Keep an eye on the time.
- Try to answer every question.
- Check your answers if you have time at the end.

Turn over ►

P49361A

©2017 Pearson Education Ltd.

6/6/6/7/2/2/



Pearson

Answer ALL questions.

Write your answers in the spaces provided.

You must write down all the stages in your working.

1 Solve  $5x - 6 = 3(x - 1)$

$$\begin{aligned} & \curvearrowright \\ 5x - 6 &= 3x - 3 \\ -3x & \quad -3x \\ \hline 2x - 6 &= -3 \\ +6 & \quad +6 \\ \hline 2x &= 3 \\ \div 2 & \quad \div 2 \\ x &= \frac{3}{2} = 1.5 \end{aligned}$$

$x = 1.5$

(Total for Question 1 is 3 marks)

- 2 Emily buys a pack of 12 bottles of water.  
The pack costs £5.64

Emily sells all 12 bottles for 50p each.

Work out Emily's percentage profit.

Give your answer correct to 1 decimal place.

$$12 \times 50p = 600p \xrightarrow{\div 100} \pounds 6$$

$$\text{Profit} = \pounds 6 - \pounds 5.64 = \pounds 0.32$$

$$\% \text{ profit} = \frac{0.32}{5.64} \times 100$$

$$= 6.382978723$$

$$\approx 6.4\%$$

$6.4\%$

(Total for Question 2 is 3 marks)

DO NOT WRITE IN THIS AREA

DO NOT WRITE IN THIS AREA

DO NOT WRITE IN THIS AREA



DO NOT WRITE IN THIS AREA

DO NOT WRITE IN THIS AREA

DO NOT WRITE IN THIS AREA

3 Hasmeet walks once round a circle with diameter 80 metres.

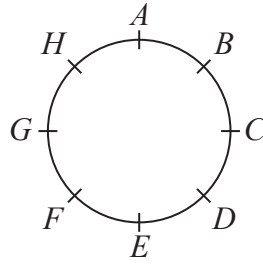

There are 8 points equally spaced on the circumference of the circle.

(a) Find the distance Hasmeet walks between one point and the next point.

$$C = \pi d \quad d = 80 \text{ m}$$

$$C = \pi(80) \\ = 80\pi \text{ m}$$

$$80\pi \div 8 = 10\pi \\ = 31.41592654 \\ = 31.4$$

..... **31.4** m  
(2)

Four of the points are moved, as shown in the diagram below.

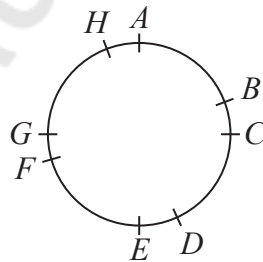

Hasmeet walks once round the circle again.

(b) Has the mean distance that Hasmeet walks between one point and the next point changed? You must give a reason for your answer.

*No. The total distance (circumference) has not changed*

(1)

(Total for Question 3 is 3 marks)



4 There are only blue cubes, yellow cubes and green cubes in a bag.

There are

twice as many blue cubes as yellow cubes  
and four times as many green cubes as blue cubes.

Hannah takes at random a cube from the bag.

Work out the probability that Hannah takes a yellow cube.

$$\text{Yellow} = 1 \quad \text{Blue} = 2 \quad \text{Green} = 8$$

$$p(\text{yellow}) = \frac{1}{11}$$

$\frac{1}{11}$

(Total for Question 4 is 3 marks)

DO NOT WRITE IN THIS AREA

DO NOT WRITE IN THIS AREA

DO NOT WRITE IN THIS AREA



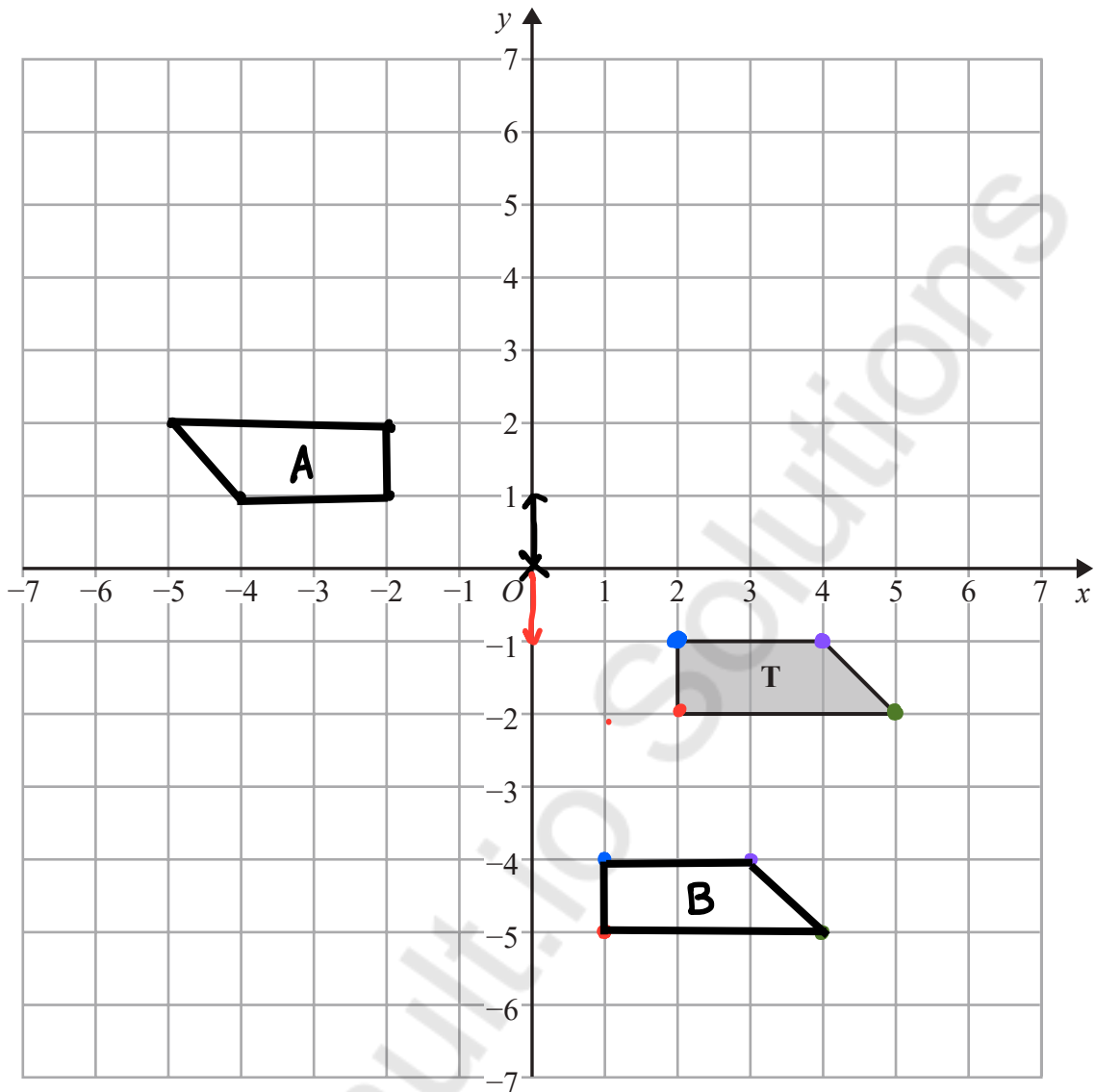

- (a) Rotate trapezium **T**  $180^\circ$  about the origin.  
Label the new trapezium **A**.

$\hookrightarrow (0,0)$

(1)

- (b) Translate trapezium **T** by the vector  $\begin{pmatrix} -1 \\ -3 \end{pmatrix} = \begin{matrix} 1 \text{ left} \\ 3 \text{ down} \end{matrix}$   
Label the new trapezium **B**.

(1)

(Total for Question 5 is 2 marks)



$$6 \quad p^3 \times p^x = p^9$$

(a) Find the value of  $x$ .

$$x^a \times x^b = x^{a+b}$$

$$p^3 \times p^x = p^{3+x} = p^9$$

$$\begin{array}{r} 3+x = 9 \\ -3 \quad -3 \\ \hline x = 6 \end{array}$$

$$x = \underline{6} \quad (1)$$

$$(7^2)^y = 7^{10}$$

(b) Find the value of  $y$ .

$$(x^a)^b = x^{a \times b}$$

$$(7^2)^y = 7^{2 \times y} = 7^{2y}$$

$$7^{2y} = 7^{10}$$

$$\begin{array}{r} 2y = 10 \\ \div 2 \quad \div 2 \end{array}$$

$$y = 5$$

$$y = \underline{5} \quad (1)$$

$10^a \times 1000^b$  can be written in the form  $10^w$

(c) Show that  $w = 2a + 3b$

$$100 = 10^2 \quad 1000 = 10^3$$

$$(10^2)^a \times (10^3)^b = 10^w$$

$$10^{2a} \times 10^{3b} = 10^w$$

$$10^{2a+3b} = 10^w$$

$$\therefore w = 2a + 3b$$

(2)

(Total for Question 6 is 4 marks)



7  $ABCD$  is a trapezium.

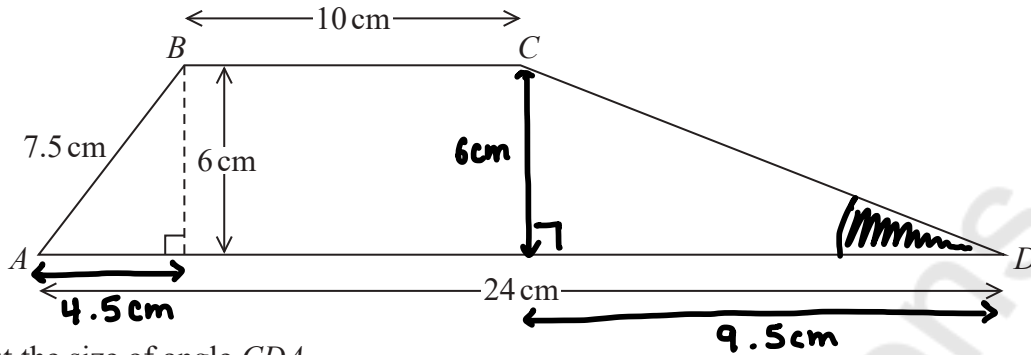

Work out the size of angle  $CDA$ .

Give your answer correct to 1 decimal place.

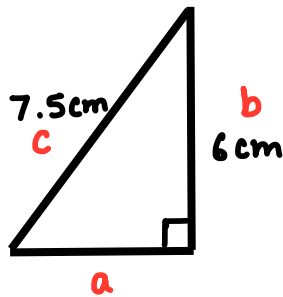

$$a^2 + b^2 = c^2$$

$$a^2 + 6^2 = 7.5^2$$

$$a^2 = 7.5^2 - 6^2$$

$$\sqrt{\quad} \quad \sqrt{\quad}$$

$$a = \sqrt{7.5^2 - 6^2}$$

$$= 4.5 \text{ cm}$$

$$24 \text{ cm} - 4.5 \text{ cm} - 10 \text{ cm} = 9.5 \text{ cm}$$

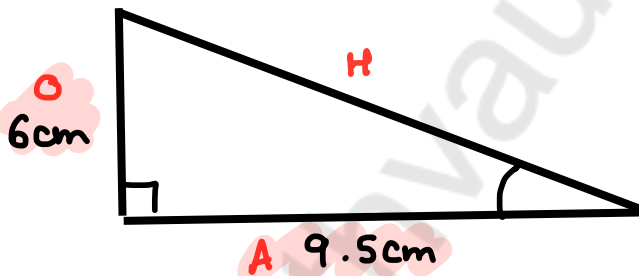

$$\sin \theta = \frac{O}{H} \quad \cos \theta = \frac{A}{H} \quad \tan \theta = \frac{O}{A}$$

$$\tan(\theta) = \frac{6}{9.5}$$

$$\theta = \tan^{-1}\left(\frac{6}{9.5}\right)$$

$$= 32.27564431$$

$$\approx 32.3^\circ$$

32.3

(Total for Question 7 is 5 marks)



8 Use your calculator to work out  $\sqrt{\frac{\sin 25^\circ + \sin 40^\circ}{\cos 25^\circ - \cos 40^\circ}}$

(a) Write down all the figures on your calculator display.

2.75603957

(2)

(b) Write your answer to part (a) correct to 2 decimal places.

2.76

(1)

(Total for Question 8 is 3 marks)

9 Yesterday it took 5 cleaners  $4\frac{1}{2}$  hours to clean all the rooms in a hotel.

There are only 3 cleaners to clean all the rooms in the hotel today.

Each cleaner is paid £8.20 for each hour or part of an hour they work.

How much will each cleaner be paid today?

$$\begin{array}{l} \div 5 \left( \begin{array}{l} 5 \text{ cleaners} = 4.5 \text{ h} \\ 1 \text{ cleaner} = 22.5 \text{ h} \end{array} \right) \times 5 \\ \times 3 \left( \begin{array}{l} 3 \text{ cleaners} = 7.5 \text{ h} \end{array} \right) \div 3 \end{array}$$

$$8 \times £8.20 = £65.60$$

£ 65.60

(Total for Question 9 is 3 marks)



10 Here is part of a distance-time graph for a car's journey.

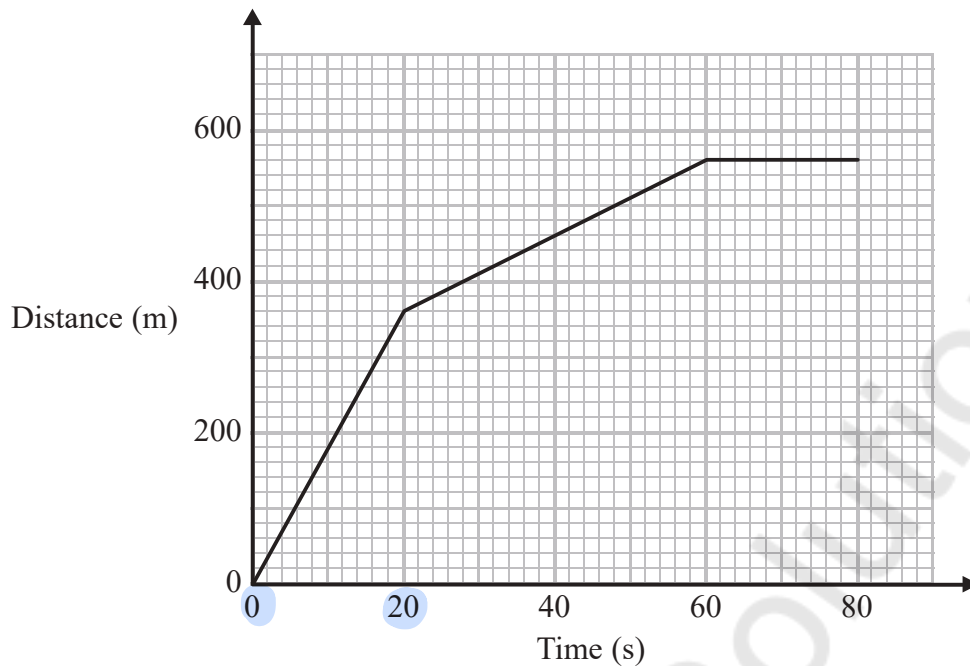

- (a) Between which two times does the car travel at its greatest speed?  
Give a reason for your answer.

0 and 20 seconds. The gradient is the steepest.

(2)

- (b) Work out this greatest speed.

$$S = \frac{D}{T} \quad D = 360\text{m}$$

$$T = 20\text{s}$$

$$S = \frac{360\text{m}}{20\text{s}}$$

$$= 18\text{ m/s}$$

18 m/s  
(1)

(Total for Question 10 is 3 marks)



11 The pie charts give information about the ages, in years, of people living in two towns, Adley and Bridford.

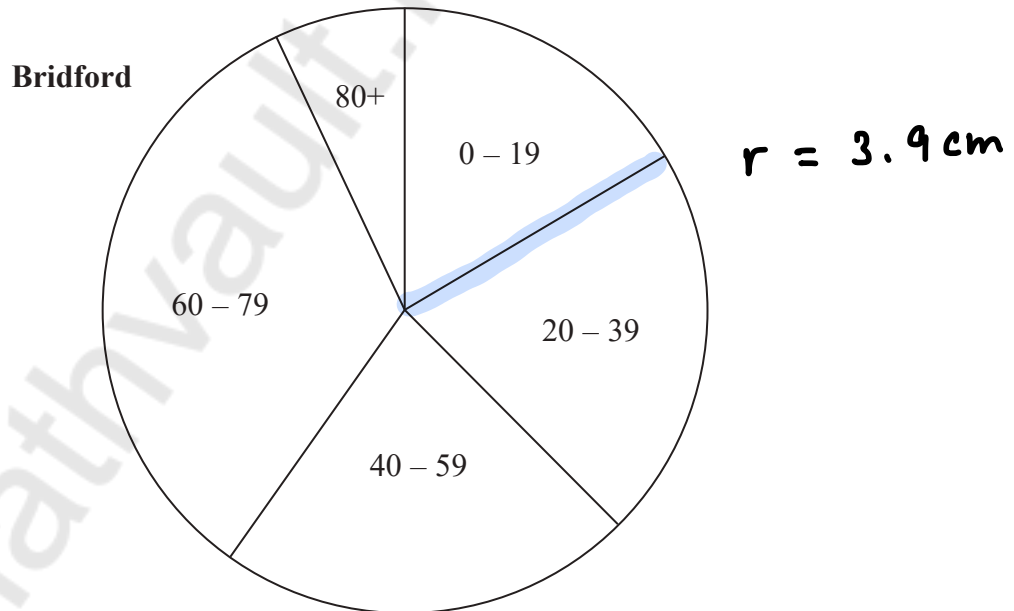
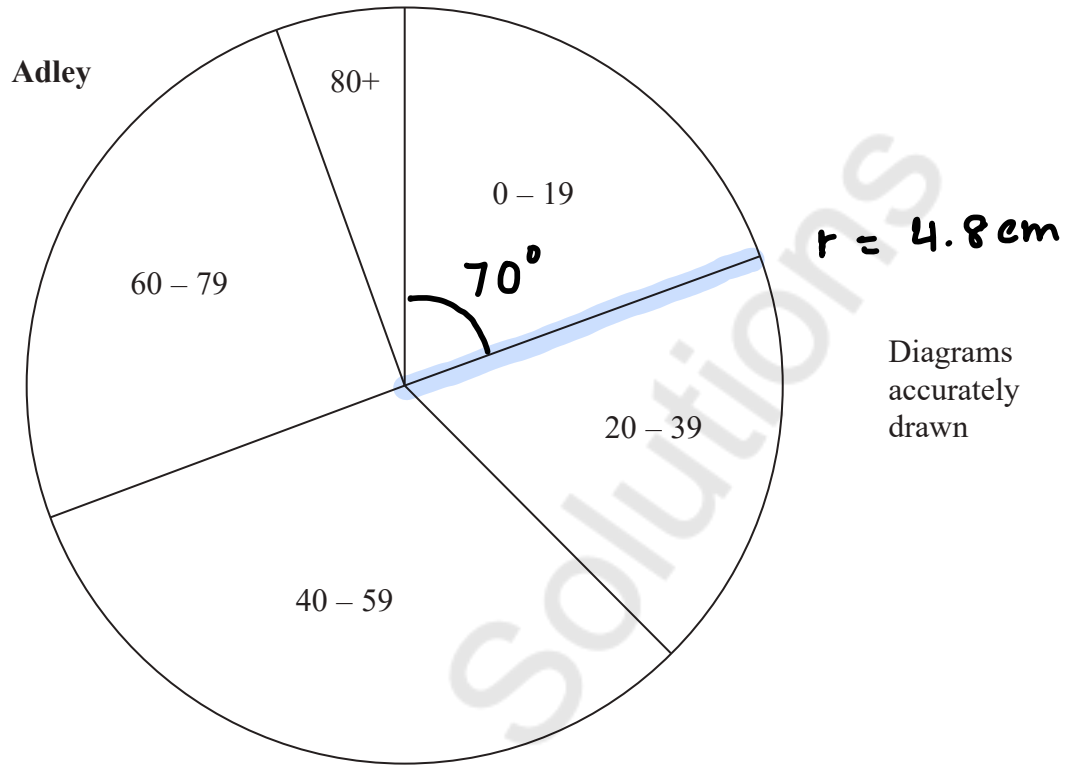

DO NOT WRITE IN THIS AREA

DO NOT WRITE IN THIS AREA

DO NOT WRITE IN THIS AREA



The ratio of the number of people living in Adley to the number of people living in Bridford is given by the ratio of the areas of the pie charts.

What proportion of the total number of people living in these two towns live in Adley and are aged 0 – 19?

Give your answer correct to 3 significant figures.

Adley Area  $A = \pi r^2$   
 $= \pi (4.8)^2 = \frac{576}{25} \pi \text{ cm}^2$

Bridford Area  $A = \pi r^2$   
 $= \pi (3.9)^2 = \frac{1521}{100} \pi$

Total Area  $= \frac{576}{25} \pi + \frac{1521}{1000} \pi = \frac{153}{4} \pi$

Adley 0-19 Area  $\frac{0}{360} \times \pi r^2$   
 $\frac{70}{360} \times \pi (4.8)^2$   
 $= \frac{112}{25} \pi$

Proportion  $= \frac{\text{0-19 Adley}}{\text{total area}}$   
 $= \frac{112}{25} \pi \div \frac{153}{4} \pi =$   
 $= 0.117124... = 0.117$   
 $\times 100 = 11.7\%$

(Total for Question 11 is 3 marks)

DO NOT WRITE IN THIS AREA

DO NOT WRITE IN THIS AREA

DO NOT WRITE IN THIS AREA



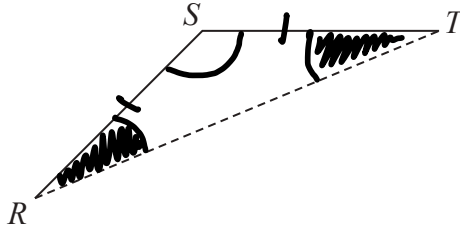

$RS$  and  $ST$  are 2 sides of a regular 12-sided polygon.  
 $RT$  is a diagonal of the polygon.

Work out the size of angle  $STR$ .  
 You must show your working.

$$\text{Exterior} = \frac{360}{n} = \frac{360}{12} = 30^\circ$$

$$\text{Interior} = 180 - 30 = 150^\circ$$

$$180 - 150 = 30^\circ$$

$$30^\circ \div 2 = 15^\circ$$

..... 15 °

(Total for Question 12 is 3 marks)



DO NOT WRITE IN THIS AREA

DO NOT WRITE IN THIS AREA

DO NOT WRITE IN THIS AREA

- 13 At the beginning of 2009, Mr Veale bought a company.  
The value of the company was £50 000

Each year the value of the company increased by 2%.

- (a) Calculate the value of the company at the beginning of 2017  
Give your answer correct to the nearest £100

$$\text{Final amount} = \text{initial} \times \text{multiplier}^n \quad n \leftarrow \text{no. of years}$$

$$\text{Multiplier} = 100\% + 2\% = 102\% \xrightarrow{\div 100} 1.02$$

$$\text{No. of years} = 2017 - 2009 = 8$$

$$50,000 \times 1.02^8 = 58,582.97$$

$$\approx 58,600.00$$

$$\text{£ } 58,600$$

(2)

At the beginning of 2009 the value of a different company was £250 000  
In 6 years the value of this company increased to £325 000

This is equivalent to an increase of  $x\%$  each year.

- (b) Find the value of  $x$ .  
Give your answer correct to 2 significant figures.

$$\text{Final amount} = \text{initial} \times \text{multiplier}^n$$

$$\text{Multiplier} = 100 + x \div 100 = \frac{100 + x}{100}$$

$$325,000 = 250,000 \times \left(\frac{100 + x}{100}\right)^6$$

$$\div 250,000 \quad \div 250,000$$

$$1.3 = \left(\frac{100 + x}{100}\right)^6$$

$$\sqrt[6]{\quad} \quad \sqrt[6]{\quad}$$

$$1.044697508 = \frac{100 + x}{100}$$

$$\times 100 \quad \times 100$$

$$104.4697508 = 100 + x$$

$$- 100 \quad - 100$$

$$x = 4.4697508$$

$$\approx 4.5$$

$$4.5$$

(3)

(Total for Question 13 is 5 marks)



14 On the grid, shade the region that satisfies all these inequalities.

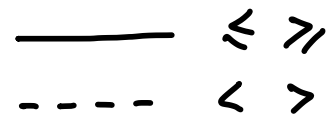

$$y > 1$$

$$x + y < 5$$

$$y > 2x$$

Label the region R.

$x$	0	1	2
$y$	5	4	3

$x$	0	1	2
$y$	0	2	4

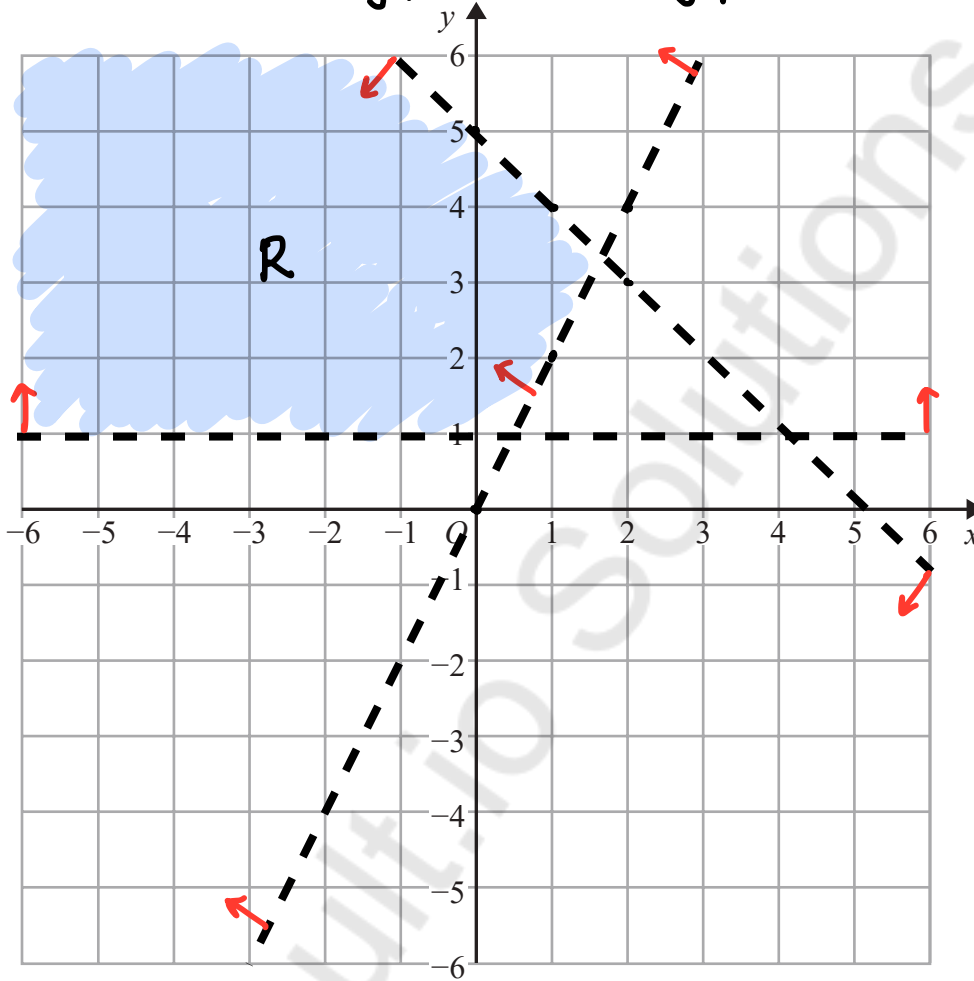

(Total for Question 14 is 3 marks)

DO NOT WRITE IN THIS AREA

DO NOT WRITE IN THIS AREA

DO NOT WRITE IN THIS AREA



- 15 Tracey is going to choose a main course and a dessert in a cafe. She can choose from 8 main courses and 7 desserts.

Tracey says that to work out the number of different ways of choosing a main course and a dessert you add 8 and 7

- (a) Is Tracey correct?  
You must give a reason for your answer.

No. You must  $8 \times 7 = 56$

(1)

12 teams play in a competition.  
Each team plays each other team exactly once.

- (b) Work out the total number of games played.

$$12 \times 11 = 132$$

$$\frac{132}{2} = 66 \text{ games}$$

66

(2)

(Total for Question 15 is 3 marks)

- 16 Solve  $(x - 2)^2 = 3$

Give your solutions correct to 3 significant figures.

$$\sqrt{(x - 2)^2} = \sqrt{3}$$

$$x - 2 = \pm \sqrt{3}$$

$$+2 \quad +2$$

$$x = 2 + \sqrt{3} = 3.732050808 \approx 3.73$$

$$x = 2 - \sqrt{3} = 0.2679491924 \approx 0.268$$

0.268 or 3.73

(Total for Question 16 is 2 marks)



17 The table gives information about the heights of 150 students.

F  
CW FD

Height ( $h$ cm)	Frequency
$140 < h \leq 150$	15
$150 < h \leq 155$	30
$155 < h \leq 160$	51
$160 < h \leq 165$	36
$165 < h \leq 180$	18

FD

$$\frac{FD}{\text{width}} = \text{Frequency Density}$$

$$15 \div 10 = 1.5$$

$$30 \div 5 = 6$$

$$51 \div 5 = 10.2$$

$$36 \div 5 = 7.2$$

$$18 \div 15 = 1.2$$

(a) On the grid, draw a histogram for this information.

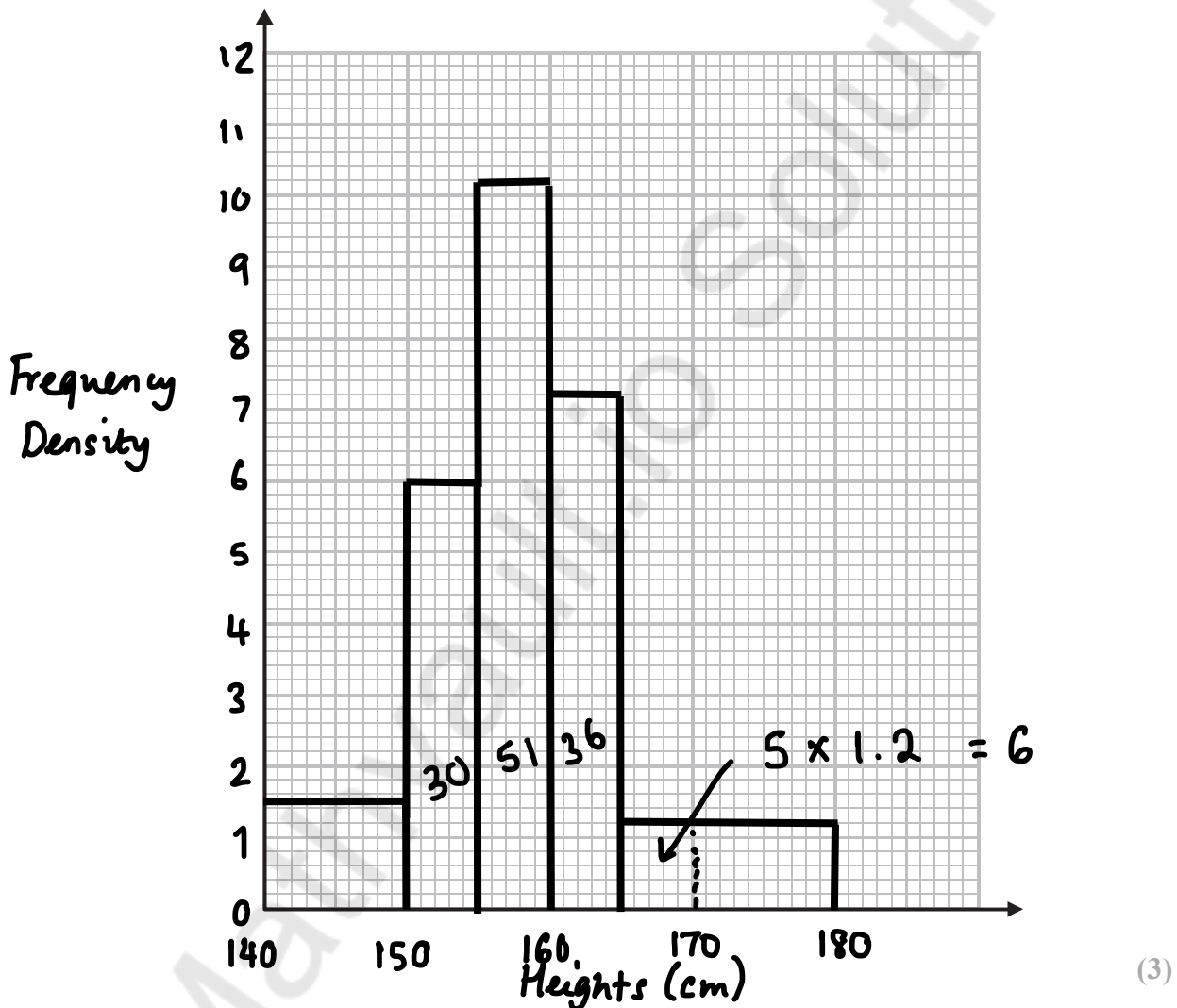

(b) Work out an estimate for the fraction of the students who have a height between 150 cm and 170 cm.

$$\frac{30 + 51 + 36 + 6}{150} = \frac{123}{150} = \frac{41}{50}$$

(2)

(Total for Question 17 is 5 marks)



DO NOT WRITE IN THIS AREA

DO NOT WRITE IN THIS AREA

DO NOT WRITE IN THIS AREA

18 At time  $t = 0$  hours a tank is full of water.

Water leaks from the tank.

At the end of every hour there is 2% less water in the tank than at the start of the hour.

The volume of water, in litres, in the tank at time  $t$  hours is  $V_t$

Given that

$$V_0 = 2000$$

$$V_{t+1} = kV_t$$

write down the value of  $k$ .

$$k = 100\% - 2\% = 98\% \xrightarrow{\div 100} 0.98$$

$$k = \underline{0.98}$$

(Total for Question 18 is 1 mark)

Mathvault.io Solutions



19 A triangle has vertices  $P$ ,  $Q$  and  $R$ .

The coordinates of  $P$  are  $(-3, -6)$

The coordinates of  $Q$  are  $(1, 4)$

The coordinates of  $R$  are  $(5, -2)$

$M$  is the midpoint of  $PQ$ .

$N$  is the midpoint of  $QR$ .

Prove that  $MN$  is parallel to  $PR$ .

You must show each stage of your working.

Parallel = same gradient

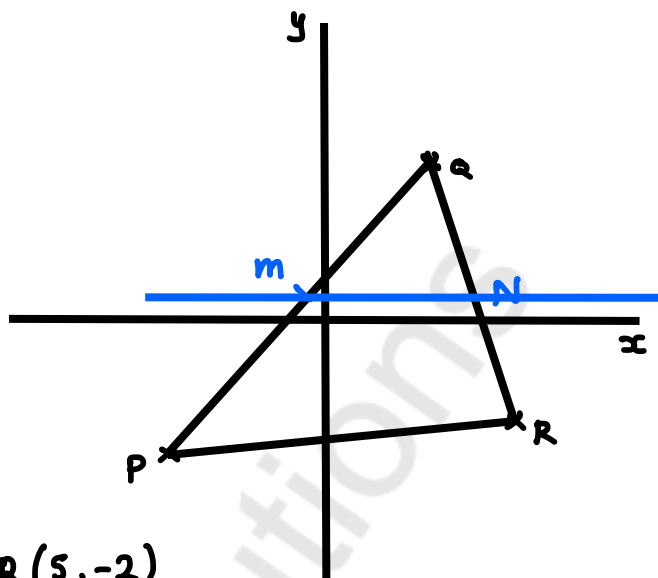

PR

$$m = \frac{y_2 - y_1}{x_2 - x_1} \quad P(-3, -6) \quad R(5, -2)$$

$x_1 \quad y_1 \quad x_2 \quad y_2$

$$m = \frac{-2 - (-6)}{5 - (-3)} = \frac{4}{8} = \frac{1}{2}$$

M (midpoint of  $PQ$ )  $P(-3, -6)$   $Q(1, 4)$

$$\text{midpoint} = \left( \frac{x_1 + x_2}{2}, \frac{y_1 + y_2}{2} \right)$$

$$= \left( \frac{-3 + 1}{2}, \frac{-6 + 4}{2} \right)$$

$$= (-1, -1)$$

$x_1 \quad y_1$

N (midpoint of  $QR$ )  
 $Q(1, 4)$   $R(5, -2)$

midpoint =

$$= \left( \frac{1 + 5}{2}, \frac{4 + (-2)}{2} \right)$$

$$= (3, 1)$$

$x_2 \quad y_2$

Gradient of  $MN$

$$m = \frac{y_2 - y_1}{x_2 - x_1}$$

$$= \frac{1 - (-1)}{3 - (-1)} = \frac{2}{4} = \frac{1}{2}$$

Same gradients ( $\frac{1}{2}$ )  
 $\therefore$  parallel.

(Total for Question 19 is 4 marks)



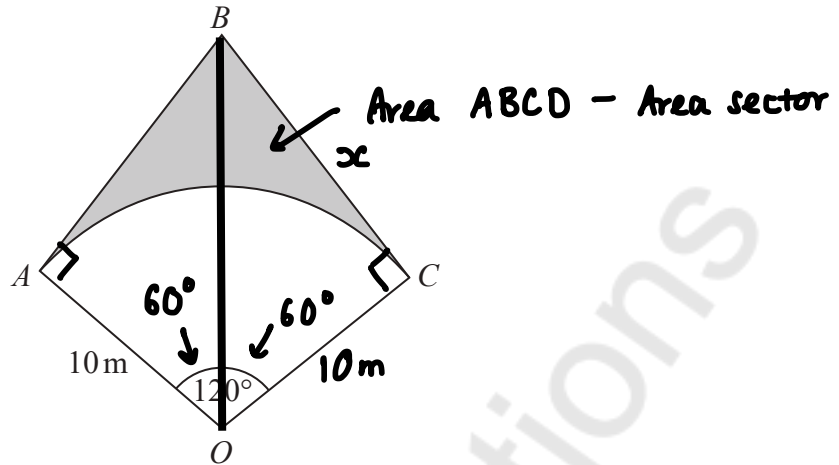

$OAC$  is a sector of a circle, centre  $O$ , radius 10 m.

$BA$  is the tangent to the circle at point  $A$ .

$BC$  is the tangent to the circle at point  $C$ .

Angle  $AOC = 120^\circ$

Calculate the area of the shaded region.

Give your answer correct to 3 significant figures.

Area ABCD

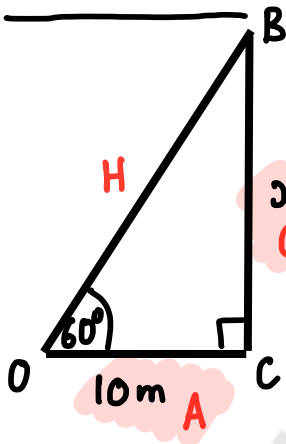

$$\sin \theta = \frac{\theta}{H} \quad \cos \theta = \frac{A}{H} \quad \tan \theta = \frac{\theta}{A}$$

$$\tan \theta = \frac{\theta}{A}$$

$$\tan(60) = \frac{x}{10}$$

$$10 \times \tan(60) = x$$

$$10\sqrt{3} \text{ m} = x$$

$$A = \frac{1}{2} b \times h$$

$$= \frac{1}{2} 10 \times 10\sqrt{3}$$

$$= 86.60254038$$

$$2 \times 86.60254038$$

$$173.2050808 \text{ m}^2$$

Area sector

$$\frac{\theta}{360} \times \pi r^2$$

$$= \frac{120}{360} \times \pi (10)^2$$

$$= \frac{100}{3} \pi \text{ m}^2$$

Shaded Area

$$173.2050808 - \frac{100}{3} \pi$$

$$= 68.48532568$$

$$\approx 68.5 \text{ m}^2$$

$$68.5 \text{ m}^2$$

(Total for Question 20 is 5 marks)



21 There are 12 counters in a bag.

There is an equal number of red counters, blue counters and yellow counters in the bag.  
There are no other counters in the bag.

3 counters are taken at random from the bag.

(a) Work out the probability of taking 3 red counters.

$$12 \div 3 = 4 \quad \text{Red} = 4 \quad \text{Blue} = 4 \quad \text{Yellow} = 4$$

$$p(\text{1st red}) = \frac{4}{12}$$

$$p(\text{2nd red}) = \frac{3}{11}$$

$$p(\text{3rd red}) = \frac{2}{10}$$

$$\begin{aligned} p(\text{3 red}) &= \frac{4}{12} \times \frac{3}{11} \times \frac{2}{10} \\ &= \frac{24}{1320} = \frac{1}{55} \end{aligned}$$

$$\frac{1}{55}$$

(2)

The 3 counters are put back into the bag.

Some more counters are now put into the bag.

There is still an equal number of red counters, blue counters and yellow counters in the bag.  
There are no counters of any other colour in the bag.

3 counters are taken at random from the bag.

(b) Is it now less likely or equally likely or more likely that the 3 counters will be red?

You must show how you get your answer.

e.g. 6 counters added      Total = 12 + 6 = 18

$$\text{Red} = 6 \quad \text{Blue} = 6 \quad \text{Yellow} = 6$$

$$p(\text{1st red}) = \frac{6}{18}$$

$$p(\text{2nd red}) = \frac{5}{17}$$

$$p(\text{3rd red}) = \frac{4}{16}$$

$$\begin{aligned} p(\text{3 red}) &= \frac{6}{18} \times \frac{5}{17} \times \frac{4}{16} \\ &= \frac{120}{4896} = \frac{5}{204} \end{aligned}$$

$$\frac{1}{55} < \frac{5}{204} \quad \text{more likely.}$$

$$0.018 \quad 0.0245\dots$$

(2)

(Total for Question 21 is 4 marks)



DO NOT WRITE IN THIS AREA

DO NOT WRITE IN THIS AREA

DO NOT WRITE IN THIS AREA

22 The functions  $f$  and  $g$  are such that

$$f(x) = 5x + 3 \quad g(x) = ax + b \quad \text{where } a \text{ and } b \text{ are constants.}$$

$$g(3) = 20 \quad \text{and} \quad f^{-1}(33) = g(1)$$

Find the value of  $a$  and the value of  $b$ .

$$g(x) = ax + b$$

$$g(3) = a(3) + b = 20$$

$$3a + b = 20$$

$$f(x) = 5x + 3$$

$$y = 5x + 3$$

$$x = \frac{5y + 3}{5}$$

$$x - 3 = 5y$$

$\div 5$

$$\frac{x - 3}{5} = y$$

$$f^{-1}(x) = \frac{x - 3}{5}$$

$$f^{-1}(33) = \frac{33 - 3}{5} = \frac{30}{5} = 6$$

$$g(1) = a(1) + b = a + b$$

$$6 = a + b$$

$$3a + b = 20$$

$$a + b = 6$$

$$\hline 2a = 14$$

$\div 2$   $\div 2$

$$a = 7$$

$$a + b = 6$$

$$7 + b = 6$$

$$-7 \quad -7$$

$$b = -1$$

$$a = 7$$

$$b = -1$$

(Total for Question 22 is 5 marks)



23 S is a geometric sequence.

- (a) Given that  $(\sqrt{x} - 1)$ , 1 and  $(\sqrt{x} + 1)$  are the first three terms of S, find the value of  $x$ .  
You must show all your working.

$$\sqrt{x} - 1, \quad 1, \quad \sqrt{x} + 1$$

$\xrightarrow{x/\div}$        $\xrightarrow{x/\div}$

$$\frac{1}{\sqrt{x} - 1} = \frac{\sqrt{x} + 1}{1}$$

$$1 = (\sqrt{x} - 1)(\sqrt{x} + 1)$$

$$1 = x + \sqrt{x} - \sqrt{x} - 1$$

$$1 = x - 1$$

$$+1 \quad +1$$

$$2 = x$$

$$x = 2$$

(3)

- (b) Show that the 5th term of S is  $7 + 5\sqrt{2}$

$$\sqrt{2} - 1, \quad 1, \quad \sqrt{2} + 1$$

$\times \sqrt{2} + 1$  (Term-to-term rule)

4th

$$(\sqrt{2} + 1)(\sqrt{2} + 1)$$

$$2 + \sqrt{2} + \sqrt{2} + 1$$

$$2\sqrt{2} + 3$$

5th

$$(2\sqrt{2} + 3)(\sqrt{2} + 1)$$

$$4 + 2\sqrt{2} + 3\sqrt{2} + 3$$

$$\boxed{7 + 5\sqrt{2}}$$

(2)

(Total for Question 23 is 5 marks)

TOTAL FOR PAPER IS 80 MARKS



DO NOT WRITE IN THIS AREA

DO NOT WRITE IN THIS AREA

DO NOT WRITE IN THIS AREA

Mathvault.io Solutions

**BLANK PAGE**



Mathvault.io Solutions

**BLANK PAGE**

DO NOT WRITE IN THIS AREA

DO NOT WRITE IN THIS AREA

DO NOT WRITE IN THIS AREA

