

Please check the examination details below before entering your candidate information

Candidate surname

Other names

Centre Number

Candidate Number

**Pearson Edexcel**  
**Level 1/Level 2 GCSE (9–1)**

--	--	--	--	--

--	--	--	--	--

**Thursday 7 November 2019**

Morning (Time: 1 hour 30 minutes)

Paper Reference **1MA1/2H**

**Mathematics**

**Paper 2 (Calculator)**  
**Higher Tier**

**You must have:** Ruler graduated in centimetres and millimetres, protractor, pair of compasses, pen, HB pencil, eraser, calculator. Tracing paper may be used.

Total Marks

### Instructions

- Use **black** ink or ball-point pen.
- **Fill in the boxes** at the top of this page with your name, centre number and candidate number.
- Answer **all** questions.
- Answer the questions in the spaces provided – *there may be more space than you need.*
- You must **show all your working.**
- Diagrams are **NOT** accurately drawn, unless otherwise indicated.
- **Calculators may be used.**
- If your calculator does not have a  $\pi$  button, take the value of  $\pi$  to be 3.142 unless the question instructs otherwise.



### Information

- The total mark for this paper is 80
- The marks for **each** question are shown in brackets – *use this as a guide as to how much time to spend on each question.*

### Advice

- Read each question carefully before you start to answer it.
- Keep an eye on the time.
- Try to answer every question.
- Check your answers if you have time at the end.

Turn over ►

P58874A

©2019 Pearson Education Ltd.

6/1/1/



  
**Pearson**

Answer ALL questions.

Write your answers in the spaces provided.

You must write down all the stages in your working.

- 1 The table shows some information about the weights of 50 potatoes.

Weight ( $w$ grams)	Frequency
$10 < w \leq 20$	6
$20 < w \leq 30$	21
$30 < w \leq 40$	13
$40 < w \leq 50$	7
$50 < w \leq 60$	3

Iveta drew this frequency polygon for the information in the table. The frequency polygon is **not** fully correct.

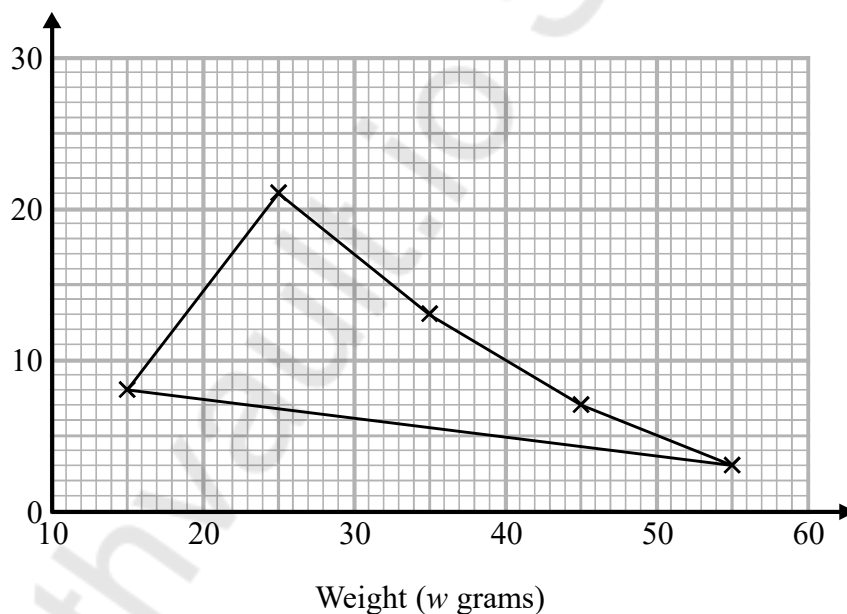

Write down two things that are wrong with the frequency polygon.

1 (15, 6) has been plotted incorrectly

2 The first and last point have been joined.

(Total for Question 1 is 2 marks)



- 2 The length of a pencil is 128 mm correct to the nearest millimetre.

Complete the error interval for the length of the pencil.

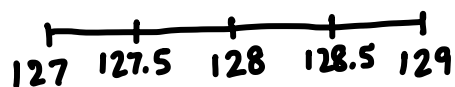

$$\dots 127.5 \dots \text{ mm} \leq \text{length} < \dots 128.5 \dots \text{ mm}$$

(Total for Question 2 is 2 marks)

- 3 Tom and Adam have a total of 240 stamps.  
The ratio of the number of Tom's stamps to the number of Adam's stamps is 3:7

Tom buys some stamps from Adam.

The ratio of the number of Tom's stamps to the number of Adam's stamps is now 3:5

How many stamps does Tom buy from Adam?

You must show all your working.

$$\begin{array}{l}
 \text{Tom : Adam} \\
 3 : 7 \quad 10 \text{ parts} \quad 240 \div 10 = 24 \\
 \downarrow \times 24 \quad \downarrow \times 24 \\
 72 \quad 168
 \end{array}$$

$$\begin{array}{l}
 \text{Tom : Adam} \\
 3 : 5 \quad 8 \text{ parts} \quad 240 \div 8 = 30 \\
 \downarrow \times 30 \quad \downarrow \times 30 \\
 90 \quad 150
 \end{array}$$

$$90 - 72 = 18$$

18

(Total for Question 3 is 4 marks)



- 4 Each person in a fitness club is going to get a free gift.  
Stan is going to order the gifts.

Stan takes a sample of 50 people in the fitness club.  
He asks each person to tell him the gift they would like.

The table shows information about his results.

Gift	Number of people
sports bag	17
gym towel	7
headphones	11
voucher	15

There are 700 people in the fitness club.

- (i) Work out how many sports bags Stan should order.

$$\frac{17}{50} \times 700 = 238$$

238

(2)

- (ii) Write down any assumption you made **and** explain how this could affect your answer.

The sample is random, so the answer could be different.

(1)

(Total for Question 4 is 3 marks)



DO NOT WRITE IN THIS AREA

DO NOT WRITE IN THIS AREA

DO NOT WRITE IN THIS AREA

5 Here are six graphs.

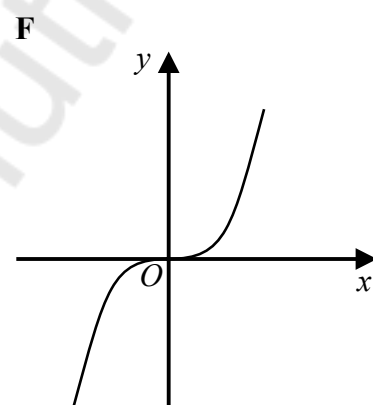
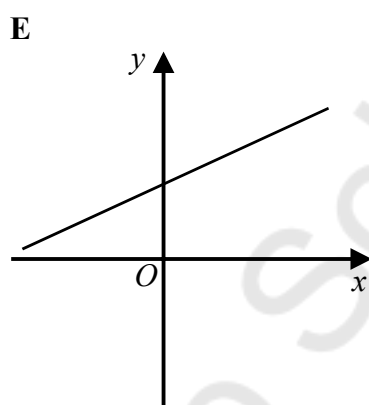
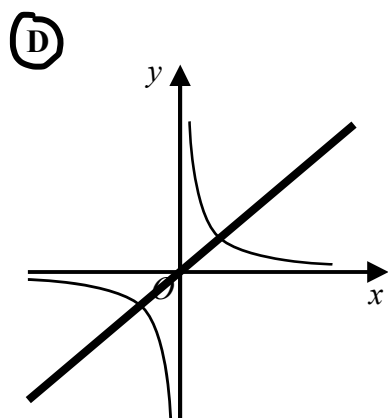
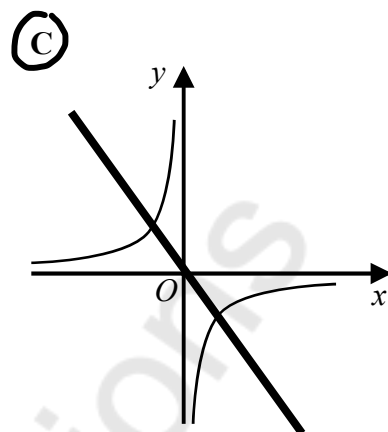
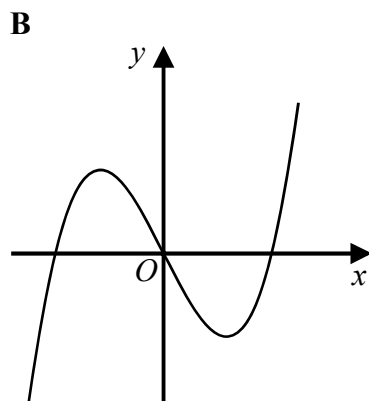
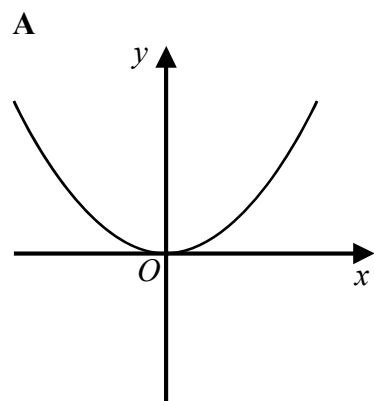

Write down the letter of the graph that could have the equation

(a)  $y = x^3$

..... **C**  
(1)

(b)  $y = \frac{1}{x}$

..... **D**  
(1)

(Total for Question 5 is 2 marks)



6 The  $n$ th term of a sequence is  $2n^2 - 1$

The  $n$ th term of a different sequence is  $40 - n^2$

Show that there is only one number that is in both of these sequences.

$$2n^2 - 1$$

$$1\text{st} \quad 2(1)^2 - 1 = 1$$

$$2\text{nd} \quad 2(2)^2 - 1 = 7$$

$$3\text{rd} \quad 2(3)^2 - 1 = 17$$

$$4\text{th} \quad 2(4)^2 - 1 = 31$$

$$5\text{th} \quad 2(5)^2 - 1 = 49$$

$$40 - n^2$$

$$40 - (1)^2 = 39$$

$$40 - (2)^2 = 36$$

$$40 - (3)^2 = 31$$

(Total for Question 6 is 3 marks)

7 Work out  $(3.42 \times 10^{-7}) \div (7.5 \times 10^{-6})$   
Give your answer in standard form.

$$= 0.0456$$

$$4.56 \times 10^{-2}$$

$$\underline{4.56 \times 10^{-2}}$$

(Total for Question 7 is 2 marks)



8 The number of days,  $d$ , that it will take to build a house is given by

$$d = \frac{720}{n}$$

where  $n$  is the number of workers used each day.

Ali's company will take 40 days to build the house.

Hayley's company will take 30 days to build the house.

Hayley's company will have to use more workers each day than Ali's company.

How many more?

Ali

$$40 = \frac{720}{n}$$

$$\begin{aligned} n &= 720 \div 40 \\ &= 18 \text{ workers} \end{aligned}$$

Hayley

$$30 = \frac{720}{n}$$

$$\begin{aligned} n &= 720 \div 30 \\ &= 24 \text{ workers} \end{aligned}$$

$$24 - 18 = 6 \text{ workers}$$

..... 6

(Total for Question 8 is 3 marks)



- 9 The diagram shows a cube and a cuboid.

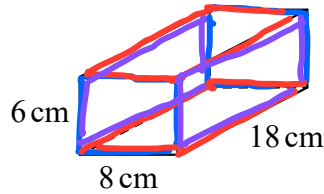
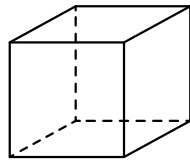

The total surface area of the cube is equal to the total surface area of the cuboid.

Janet says,

“The volume of the cube is equal to the volume of the cuboid.”

Is Janet correct?

You must show how you get your answer.

### Surface Area Cuboid

$$\text{Front \& Back} = (6 \times 8) \times 2 = 96$$

$$\text{Top \& Bottom} = (8 \times 18) \times 2 = 288$$

$$\text{Left \& Right} = (6 \times 18) \times 2 = 216$$

$$\begin{aligned} 96 + 288 + 216 \\ = 600 \text{ cm}^2 \end{aligned}$$

$$\text{Surface Area Cube} = 600 \text{ cm}^2$$

$$600 \div 6 = 100 \text{ cm}^2$$

$$\begin{array}{|c|} \hline 100 \text{ cm}^2 \\ \hline \end{array} \begin{array}{l} 10 \text{ cm} \\ 10 \text{ cm} \end{array}$$

$$\sqrt{100} = 10$$

$$\begin{aligned} \text{Volume Cube} &= l \times w \times h \\ &= 10 \times 10 \times 10 \\ &= 1000 \text{ cm}^3 \end{aligned}$$

$$\begin{aligned} \text{Volume Cuboid} &= l \times w \times h \\ &= 8 \times 18 \times 6 \\ &= 864 \text{ cm}^3 \end{aligned}$$

No.

(Total for Question 9 is 5 marks)



DO NOT WRITE IN THIS AREA

DO NOT WRITE IN THIS AREA

DO NOT WRITE IN THIS AREA

10 Make  $k$  the subject of the formula  $y = \sqrt{2m - k}$

$$y^2 = 2m - k$$

$$y^2 - 2m = -k$$

$$-y^2 + 2m = k$$

$$k = 2m - y^2$$

$$k = 2m - y^2$$

(Total for Question 10 is 2 marks)

Mathvault.io Solutions



11 Megan grows potatoes.

The box plot below shows information about the weights of Megan's potatoes.

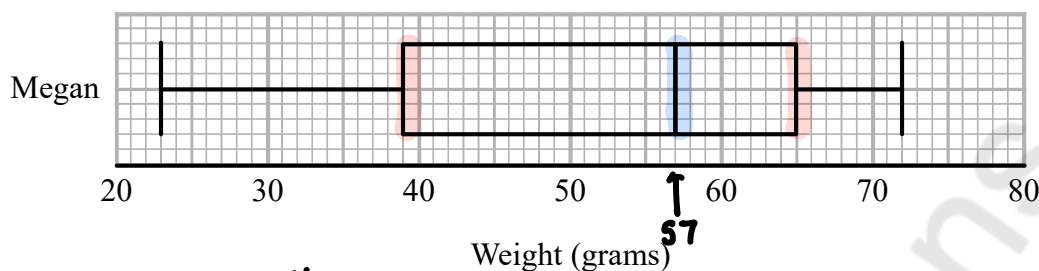

Megan says that half of her potatoes weigh less than 50 grams each.

(a) Is Megan correct?

Give a reason for your answer.

No. The median is 57 so half of her potatoes weigh less than 57 g each.

(1)

Amy also grows potatoes.

The box plot below shows information about the weights of Amy's potatoes.

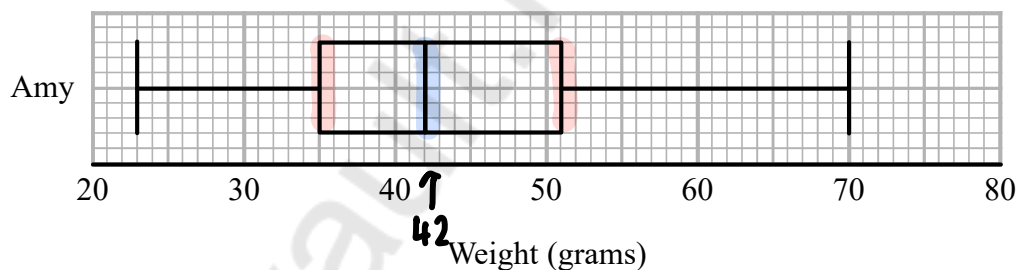

(b) Compare the distribution of the weights of Megan's potatoes with the distribution of the weights of Amy's potatoes.

The median of Megan's potatoes is greater than the median of Amy's potatoes.

The interquartile range of Megan's potatoes is larger than the interquartile range of Amy's potatoes.

(2)

(Total for Question 11 is 3 marks)



12 The diagram shows triangle  $ABC$ .

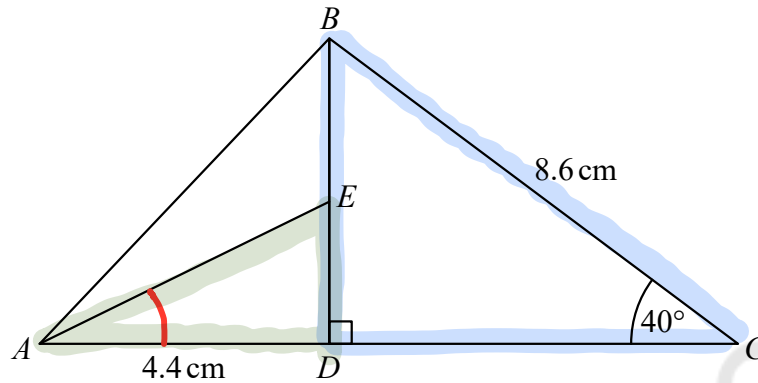

$ADC$  and  $DEB$  are straight lines.

$$AD = 4.4 \text{ cm}$$

$$BC = 8.6 \text{ cm}$$

$E$  is the midpoint of  $DB$ .

$$\text{Angle } CDB = 90^\circ$$

$$\text{Angle } DCB = 40^\circ$$

Work out the size of angle  $EAD$ .

Give your answer correct to 1 decimal place.

You must show all your working.

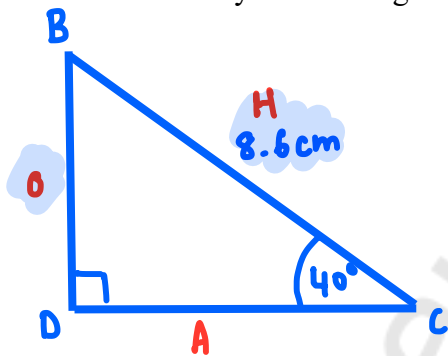

$$\sin \theta = \frac{O}{H}$$

$$\sin(40) = \frac{BD}{8.6}$$

$$8.6 \sin(40) = BD$$

$$BD = 5.527973443 \text{ cm}$$

$$ED = BD \div 2$$

$$= 2.763986722$$

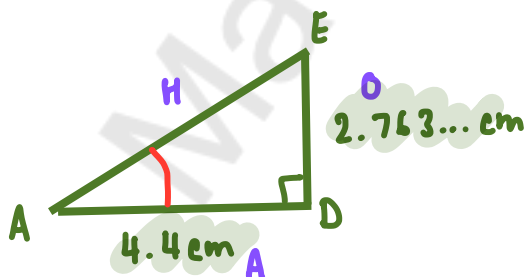

$$\tan \theta = \frac{O}{A}$$

$$\tan \theta = \frac{2.763...}{4.4}$$

$$\theta = \tan^{-1}(\uparrow)$$

$$= 32.13616735$$

$$\approx 32.1^\circ$$

$$32.1^\circ$$

(Total for Question 12 is 4 marks)



13 Sakira invested £3550 in a savings account for 3 years.

She was paid 2.6% per annum compound interest for each of the first 2 years.  
She was paid  $R\%$  interest for the third year.

Sakira had £3819.21 in her savings account at the end of the 3 years.

Work out the value of  $R$ .

Give your answer correct to 1 decimal place.

$$100 + 2.6 = 102.6 \div 100 \\ = 1.026$$

$$3819.21 = 3550 \times 1.026^2 \times \left(\frac{100 + R}{100}\right)^1$$

$$3819.21 \div (3550 \times 1.026^2) = \left(\frac{100 + R}{100}\right)^1$$

$$1.021998984 = \frac{100 + R}{100}$$

$\times 100$

$\times 100$

$$102.1998984 = 100 + R \\ -100 \qquad -100$$

$$2.1998984 = R$$

$$2.2 = R \quad (1dp)$$

2.2

(Total for Question 13 is 3 marks)



- 14 Sadia is going to buy a new car.  
For the car, she can choose one body colour, one roof colour and one wheel type.

She can choose from

- 19 different body colours
- 25 different wheel types

The total number of ways Sadia can choose the body colour and the roof colour and the wheel type is 3325

Work out the number of different roof colours that Sadia can choose from.

$$19 \times 25 \times x = 3325$$

$$x = \frac{3325}{19 \times 25}$$

$$= 7$$

7

(Total for Question 14 is 2 marks)

- 15 Expand and simplify  $(3x + 2)(2x + 1)(x - 5)$

$x$	$3x$	$+ 2$	
$2x$	$6x^2$	$+ 4x$	$= 6x^2 + 7x + 2$
$+ 1$	$+ 3x$	$+ 2$	

$x$	$6x^2$	$+ 7x$	$+ 2$	$= 6x^3 - 23x^2 - 33x - 10$
$x$	$6x^3$	$+ 7x^2$	$+ 2x$	
$- 5$	$- 30x^2$	$- 35x$	$- 10$	

$$6x^3 - 23x^2 - 33x - 10$$

(Total for Question 15 is 3 marks)



- 16 Marek has 9 cards.  
There is a number on each card.

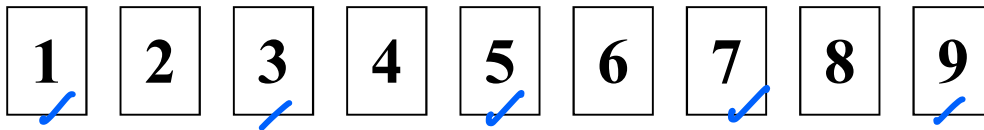

Marek takes at random two of the cards.  
He works out the product of the numbers on the two cards.

Work out the probability that the product is an even number.

$$\text{odd} \times \text{odd} = \text{odd}$$

$$\text{odd} \times \text{even} = \text{even}$$

$$\text{even} \times \text{even} = \text{even}$$

$$p(\text{odd}) = \frac{5}{9} \times \frac{4}{8}$$
$$= \frac{20}{72}$$

$$p(\text{even}) = 1 - \frac{20}{72}$$
$$= \frac{52}{72}$$

$$\frac{52}{72}$$

(Total for Question 16 is 3 marks)



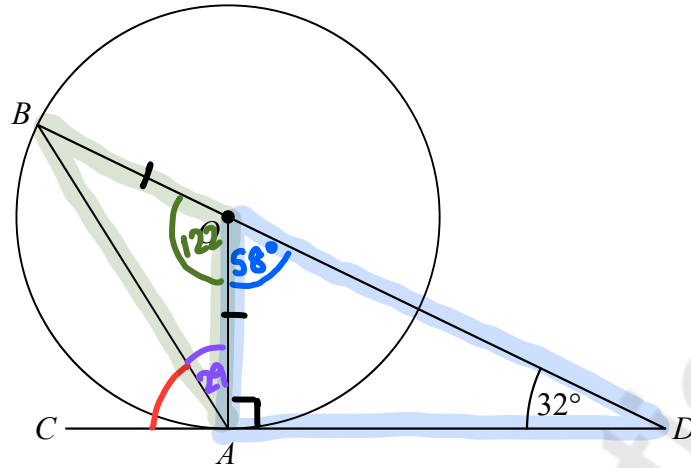

$A$  and  $B$  are points on a circle with centre  $O$ .

$CAD$  is the tangent to the circle at  $A$ .

$BOD$  is a straight line.

Angle  $ODA = 32^\circ$

Work out the size of angle  $CAB$ .

You must show all your working.

$$\begin{aligned}\angle AOD &= 180 - (90 + 32) \\ &= 58^\circ\end{aligned}$$

$$\begin{aligned}\angle BOA &= 180 - 58 \\ &= 122^\circ\end{aligned}$$

$$\begin{aligned}\angle OAB &= \frac{180 - 122}{2} \\ &= 29^\circ\end{aligned}$$

$$\angle CAB = 180^\circ - (29 + 90) = 61^\circ$$

61 °

(Total for Question 17 is 3 marks)



- 18 The histogram gives information about the heights, in metres, of the trees in a park.  
The histogram is incomplete.

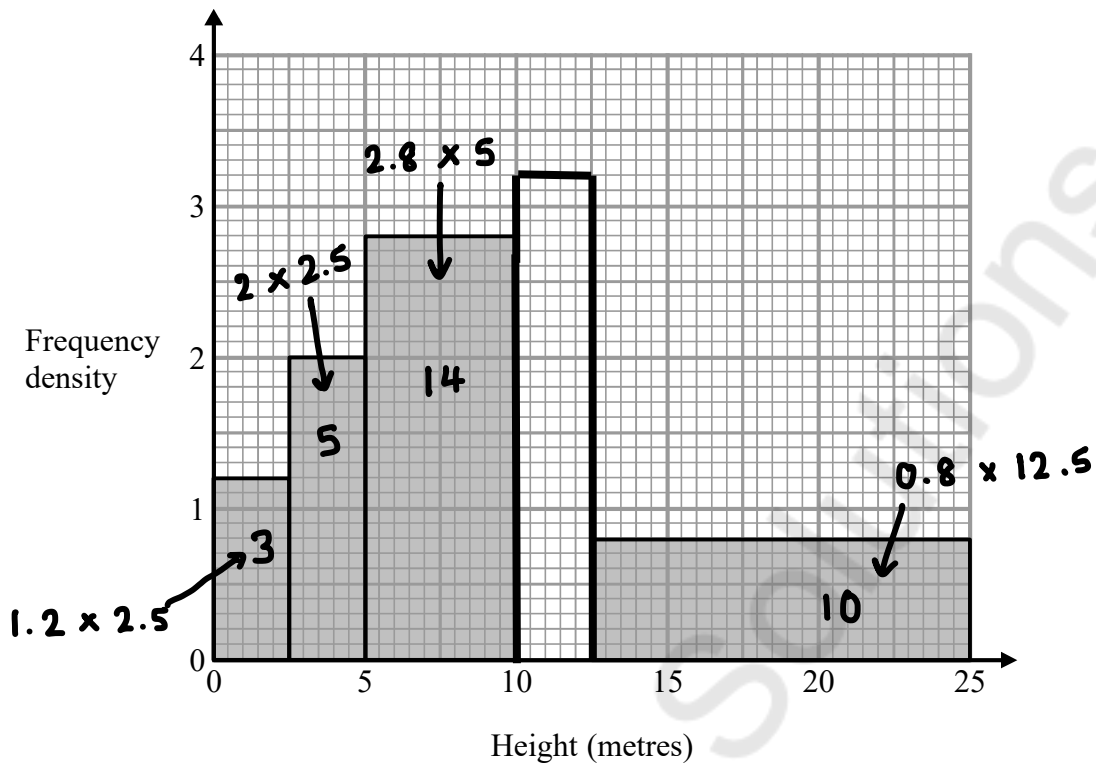

20% of the trees in the park have a height between 10 metres and 12.5 metres.  
None of the trees in the park have a height greater than 25 metres.

Complete the histogram.

$$F \quad 3 + 5 + 14 + 10 = 32$$

$$FD \quad CW$$

$$\div 4 \left( \begin{array}{l} 80\% = 32 \\ 20\% = 8 \end{array} \right) \div 4$$

$$FD = \frac{8}{2.5}$$

$$= 3.2$$

(Total for Question 18 is 3 marks)



19 The diagram shows a hemisphere with diameter 8.4 cm.

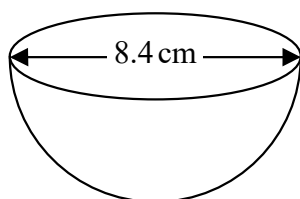

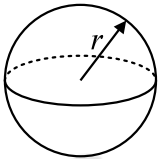
Volume of sphere =  $\frac{4}{3} \pi r^3$  

Work out the volume of the hemisphere.  
Give your answer correct to 3 significant figures.

$$\text{Vol. hemisphere} = \frac{\frac{4}{3} \pi r^3}{2} = \frac{2}{3} \pi r^3$$

$$r = 8.4 \div 2 = 4.2$$

$$\begin{aligned} \text{Vol} &= \frac{2}{3} \pi (4.2)^3 \\ &= 155.1695443 \approx 155 \end{aligned} \quad \dots\dots\dots 155 \dots\dots\dots \text{cm}^3$$

(Total for Question 19 is 2 marks)

20  $d = \frac{1}{8} c^3$

$c = 10.9$  correct to 3 significant figures.

By considering bounds, work out the value of  $d$  to a suitable degree of accuracy.  
Give a reason for your answer.

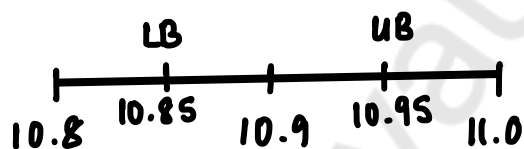

$$\begin{aligned} d_{\text{UB}} &= \frac{1}{8} C_{\text{UB}}^3 \\ &= \frac{1}{8} (10.95)^3 \\ &= 164.1166469 \end{aligned}$$

$$\begin{aligned} d_{\text{LB}} &= \frac{1}{8} C_{\text{LB}}^3 \\ &= \frac{1}{8} (10.85)^3 \\ &= 159.6611406 \end{aligned}$$

$d = 160$  as both  $d_{\text{UB}}$  and  $d_{\text{LB}}$  round to 160 to 2 significant figures. (Total for Question 20 is 4 marks)



- 21 Here is a speed-time graph for a train journey between two stations.  
The journey took 100 seconds.

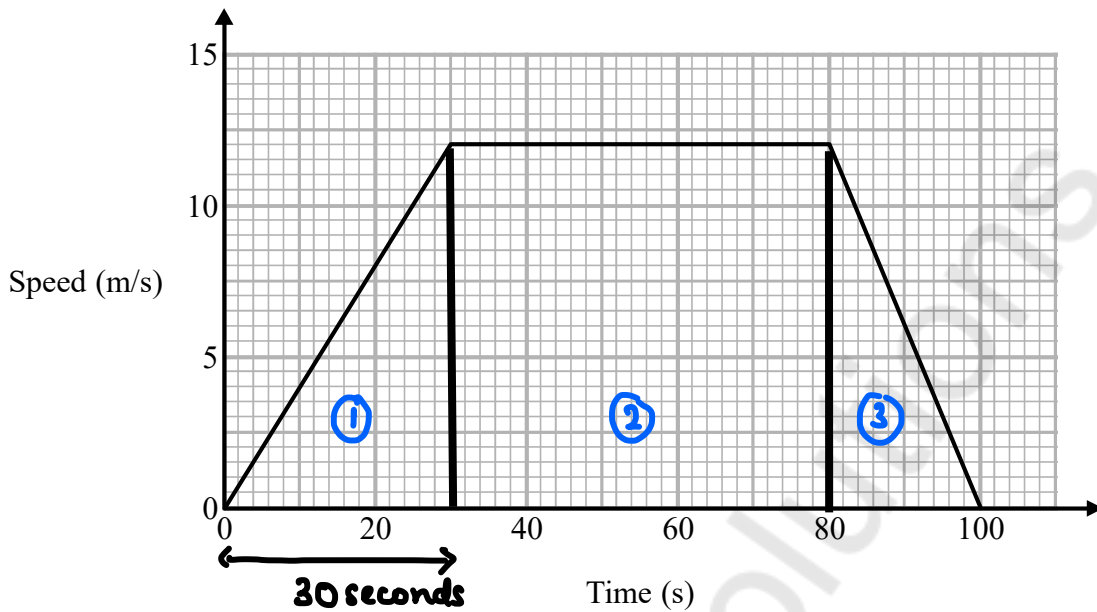

- (a) Calculate the time taken by the train to travel half the distance between the two stations.  
You must show all your working.

$$\begin{aligned} \textcircled{1} \quad A &= \frac{1}{2}bh \\ &= \frac{1}{2} \times 30 \times 12 \\ &= 180 \end{aligned}$$

$$\begin{aligned} \textcircled{2} \quad A &= l \times w \\ &= 50 \times 12 \\ &= 600 \end{aligned}$$

$$\begin{aligned} \textcircled{3} \quad A &= \frac{1}{2}bh \\ &= \frac{1}{2} \times 20 \times 12 \\ &= 120 \end{aligned}$$

$$\text{Total distance} = 180 + 600 + 120 = 900 \text{ m}$$

$$900 \text{ m} \div 2 = 450 \text{ m}$$

$$450 \text{ m} - 180 \text{ m} = 270 \text{ m}$$

$$270 \text{ m} \div 12 = 22.5 \text{ seconds}$$

$$30 + 22.5 = 52.5 \text{ seconds}$$

$$\dots\dots\dots 52.5 \dots\dots\dots \text{seconds} \quad (4)$$

- (b) Compare the acceleration of the train during the first part of its journey with the acceleration of the train during the last part of its journey.

The acceleration is positive in the first part, and negative in the last part.

(1)

(Total for Question 21 is 5 marks)



- 22 The number of rabbits on a farm at the end of month  $n$  is  $P_n$ .  
The number of rabbits at the end of the next month is given by  $P_{n+1} = 1.2P_n - 50$

At the end of March there are 200 rabbits on the farm.

- (a) Work out how many rabbits there will be on the farm at the end of June.

$$\begin{aligned} \text{April: } & 1.2(200) - 50 \\ & = 190 \end{aligned}$$

$$\begin{aligned} \text{May: } & 1.2(190) - 50 \\ & = 178 \end{aligned}$$

$$\begin{aligned} \text{June: } & 1.2(178) - 50 \\ & = 163.6 \\ & \approx 164 \end{aligned}$$

164

(3)

- (b) Considering your results in part (a), suggest what will happen to the number of rabbits on the farm after a long time.

It will decrease until there are none left.

(1)

(Total for Question 22 is 4 marks)



23 The diagram shows a parallelogram.

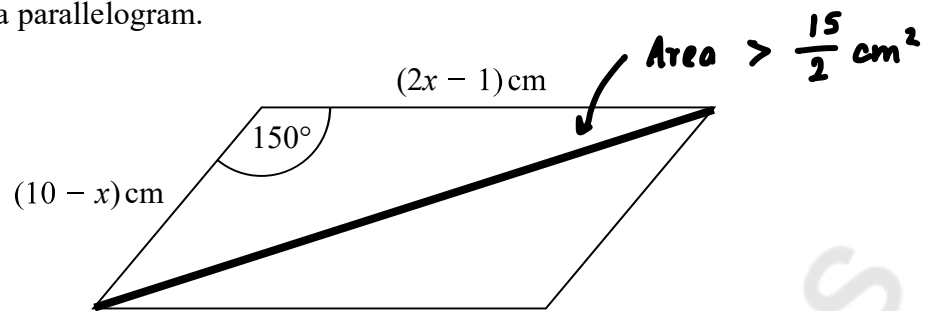

The area of the parallelogram is greater than  $15 \text{ cm}^2$

(a) Show that  $2x^2 - 21x + 40 < 0$

$$A = \frac{1}{2} ab \sin C$$

$$\frac{1}{2} (10-x)(2x-1) \sin(150) > \frac{15}{2}$$

$$(10-x)(2x-1) \left(\frac{1}{2}\right) > 15$$

$$(10-x)(2x-1) > 30$$

$$20x - 10 - 2x^2 + x > 30$$

$$-2x^2 + 21x - 10 > 30$$

$$x-1 \quad 2x^2 - 21x + 10 < -30 \quad x-1$$

$$+30 \quad 2x^2 - 21x + 40 < 0 \quad +30 \quad (3)$$

(b) Find the range of possible values of  $x$ .

$$2x^2 - 21x + 40 = 0$$

$$2 \times 40 = \frac{80}{-5 \quad -16}$$

$$2x^2 - 5x - 16x + 40$$

$$x(2x-5) - 8(2x-5)$$

$$(2x-5)(x-8) = 0$$

$$2x-5 = 0$$

$$x-8 = 0$$

$$+5 \quad +5$$

$$+8 \quad +8$$

$$2x = 5$$

$$x = 8$$

$$\div 2 \quad \div 2$$

$$x = \frac{5}{2}$$

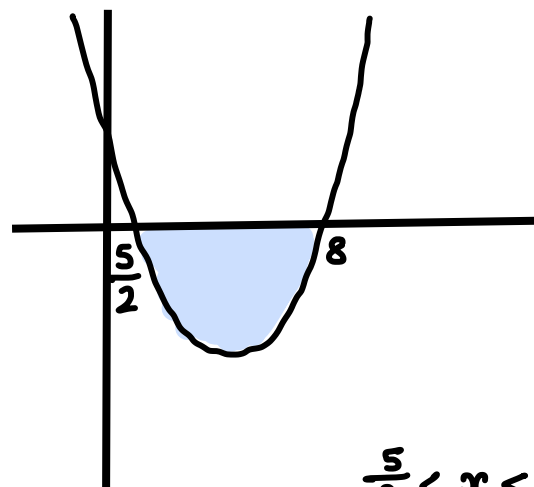

$$\frac{5}{2} < x < 8$$

(3)

(Total for Question 23 is 6 marks)



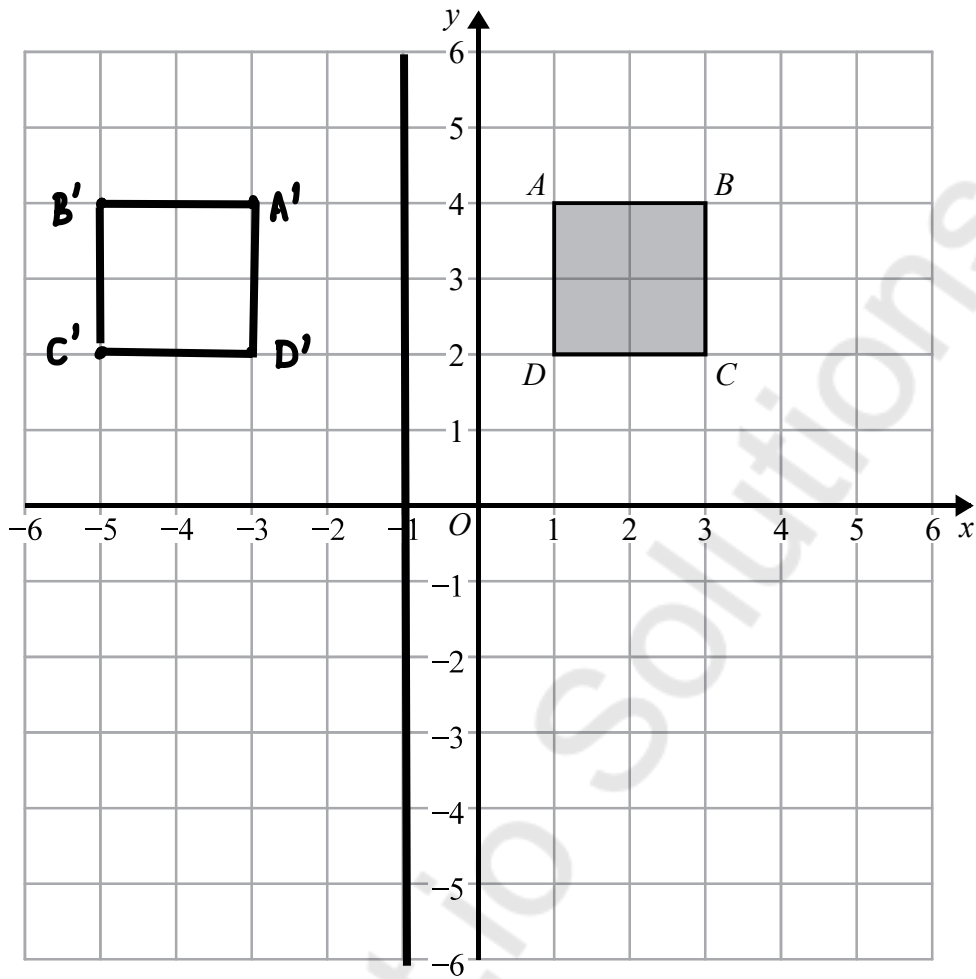

Square  $ABCD$  is transformed by a combined transformation of a reflection in the line  $x = -1$  followed by a rotation.

Under the combined transformation, two vertices of the square  $ABCD$  are invariant.

*same place*

Describe fully one possible rotation.

Rotation  $180^\circ$  about  $(-1, 4)$

Rotation  $180^\circ$  about  $(-1, 2)$  [C & D]  
 (Total for Question 24 is 2 marks)

Rotation  $90^\circ$  clockwise about  $(-1, 0)$  [B & D]

Rotation  $90^\circ$  anti-clockwise about  $(-1, 6)$  [A & C]



25 The straight line  $L$  has equation  $3x + 2y = 17$

The point  $A$  has coordinates  $(0, 2)$

The straight line  $M$  is perpendicular to  $L$  and passes through  $A$ .

Line  $L$  crosses the  $y$ -axis at the point  $B$ .

Lines  $L$  and  $M$  intersect at the point  $C$ .

Work out the area of triangle  $ABC$ .

You must show all your working.

$$\begin{aligned}
 L \quad 3x + 2y &= 17 \quad \rightarrow \quad y = mx + c \\
 -3x \quad -3x & \\
 2y &= -3x + 17 \\
 \div 2 & \quad \quad \quad \div 2 \\
 y &= -\frac{3}{2}x + \frac{17}{2} \quad m = -\frac{3}{2}
 \end{aligned}$$

Point  $B$

$$y = -\frac{3}{2}(0) + \frac{17}{2}$$

$$y = \frac{17}{2}$$

$$(0, \frac{17}{2}) \text{ or } (0, 8.5)$$

$$m \quad m = \frac{2}{3} \quad (0, 2)$$

$$y = \frac{2}{3}x + 2$$

Point  $C$

$$L \quad y = -\frac{3}{2}x + \frac{17}{2}$$

$$y = \frac{2}{3}(3) + 2$$

$$M \quad y = \frac{2}{3}x + 2$$

$$= 2 + 2$$

$$= 4$$

$$-\frac{3}{2}x + \frac{17}{2} = \frac{2}{3}x + 2$$

$$(3, 4)$$

$$+\frac{3}{2}x \quad +\frac{3}{2}x$$

$$\frac{17}{2} = \frac{13}{6}x + 2$$

$$-2$$

$$\frac{13}{2} = \frac{13}{6}x$$

$$x = 3$$

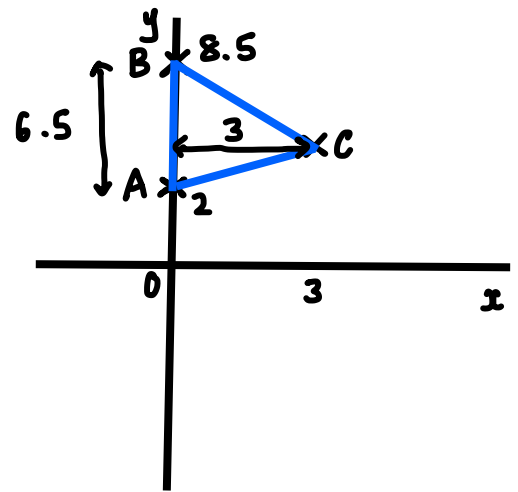

$$A = \frac{1}{2}bh$$

$$= \frac{1}{2} \times 6.5 \times 3$$

$$= 9.75$$

9.75

(Total for Question 25 is 5 marks)

TOTAL FOR PAPER IS 80 MARKS



DO NOT WRITE IN THIS AREA

DO NOT WRITE IN THIS AREA

DO NOT WRITE IN THIS AREA

Mathvault.io Solutions

**BLANK PAGE**



P 5 8 8 7 4 A 0 2 3 2 4

DO NOT WRITE IN THIS AREA

DO NOT WRITE IN THIS AREA

DO NOT WRITE IN THIS AREA

Mathvault.io Solutions

**BLANK PAGE**

