

Please check the examination details below before entering your candidate information

Candidate surname

Other names

Pearson Edexcel
Level 1/Level 2 GCSE (9-1)

Centre Number

--	--	--	--	--

Candidate Number

--	--	--	--

Time 1 hour 30 minutes

**Paper
reference**

1MA1/1H

Mathematics
PAPER 1 (Non-Calculator)
Higher Tier

You must have: Ruler graduated in centimetres and millimetres, protractor, pair of compasses, pen, HB pencil, eraser, Formulae Sheet (enclosed). Tracing paper may be used.

Total Marks

Instructions

- Use **black** ink or ball-point pen.
- **Fill in the boxes** at the top of this page with your name, centre number and candidate number.
- Answer **all** questions.
- Answer the questions in the spaces provided – *there may be more space than you need.*
- You must **show all your working**.
- Diagrams are **NOT** accurately drawn, unless otherwise indicated.
- **Calculators may not be used.**



Information

- The total mark for this paper is 80
- The marks for **each** question are shown in brackets – *use this as a guide as to how much time to spend on each question.*

Advice

- Read each question carefully before you start to answer it.
- Try to answer every question.
- Check your answers if you have time at the end.
- Good luck with your examination.

Turn over ►

P66305A

©2021 Pearson Education Ltd.

1/1/1/1



Pearson

Answer ALL questions.

Write your answers in the spaces provided.

You must write down all the stages in your working.

1 Solve $7x - 27 < 8$

$$\begin{aligned} &+ 27 \quad + 27 \\ 7x &< 35 \\ \div 7 \quad &\quad \div 7 \\ x &< 5 \end{aligned}$$

$x < 5$

(Total for Question 1 is 2 marks)

2 Write 124 as a product of its prime factors.

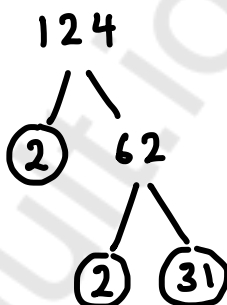

$2 \times 2 \times 31$

$2 \times 2 \times 31$

(Total for Question 2 is 2 marks)

DO NOT WRITE IN THIS AREA

DO NOT WRITE IN THIS AREA

DO NOT WRITE IN THIS AREA



3 A delivery company has a total of 160 cars and vans.

the number of cars : the number of vans = 3 : 7

Each car and each van uses electricity or diesel or petrol.

$\frac{1}{8}$ of the cars use electricity.

25% of the cars use diesel.

The rest of the cars use petrol.

Work out the number of cars that use petrol.

You must show all your working.

Cars : Vans

$$3 : 7 = 10 \text{ parts}$$

$$160 \div 10 = 16$$

$$\text{Cars} = 3 \times 16 = 48$$

Electricity

$$\frac{1}{8} \text{ of } 48 = 48 \div 8 = 6$$

Diesel

$$25\% \text{ of } 48 = 48 \div 4 = 12$$

Petrol

$$48 - 6 - 12 = 30$$

30

(Total for Question 3 is 5 marks)



4 (a) Write 1.63×10^{-3} as an ordinary number.

0.00163

0.00163

(1)

(b) Write 438 000 in standard form.

4.38×10^5

4.38×10^5

(1)

(c) Work out $(4 \times 10^3) \times (6 \times 10^{-5})$
Give your answer in standard form.

$$4 \times 6 = 24$$

$$10^3 \times 10^{-5} = 10^{3+(-5)} = 10^{-2}$$

$$24 \times 10^{-2}$$

$$\begin{array}{l} \downarrow \div 10 \qquad \downarrow +1 \\ 2.4 \times 10^{-1} \end{array}$$

2.4×10^{-1}

(2)

(Total for Question 4 is 4 marks)

DO NOT WRITE IN THIS AREA

DO NOT WRITE IN THIS AREA

DO NOT WRITE IN THIS AREA



5 Here is a regular hexagon and a regular pentagon.

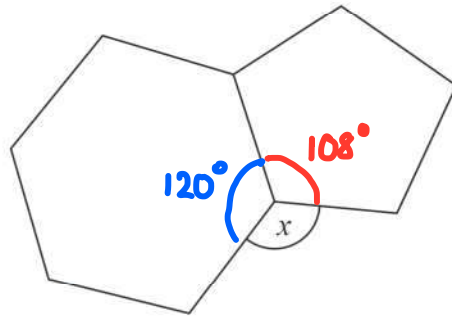

Work out the size of the angle marked x .
You must show all your working.

Hexagon

$$\text{Exterior} = 360 \div 6 = 60^\circ$$

$$\text{Interior} = 180^\circ - 60^\circ = 120^\circ$$

Pentagon

$$\text{Exterior} = 360 \div 5 = 72^\circ$$

$$\text{Interior} = 180^\circ - 72^\circ = 108^\circ$$

$$\begin{aligned} x &= 360^\circ - 120^\circ - 108^\circ \\ &= 132^\circ \end{aligned}$$

132

(Total for Question 5 is 3 marks)



- 6 (a) Complete the table of values for $y = x^2 - 3x + 1$

x	-1	0	1	2	3	4
y	5	1	-1	-1	1	5

$$\begin{aligned} & \swarrow \\ (-1)^2 - 3(-1) + 1 \\ & 1 + 3 + 1 \end{aligned}$$

$$\begin{aligned} & \swarrow \\ (2)^2 - 3(2) + 1 \\ & 4 - 6 + 1 \end{aligned}$$

$$\begin{aligned} & \uparrow \\ (3)^2 - 3(3) + 1 \\ & 9 - 9 + 1 \end{aligned}$$

$$\begin{aligned} & \swarrow \\ (4)^2 - 3(4) + 1 \\ & 16 - 12 + 1 \end{aligned}$$

(2)

- (b) On the grid, draw the graph of $y = x^2 - 3x + 1$ for values of x from -1 to 4

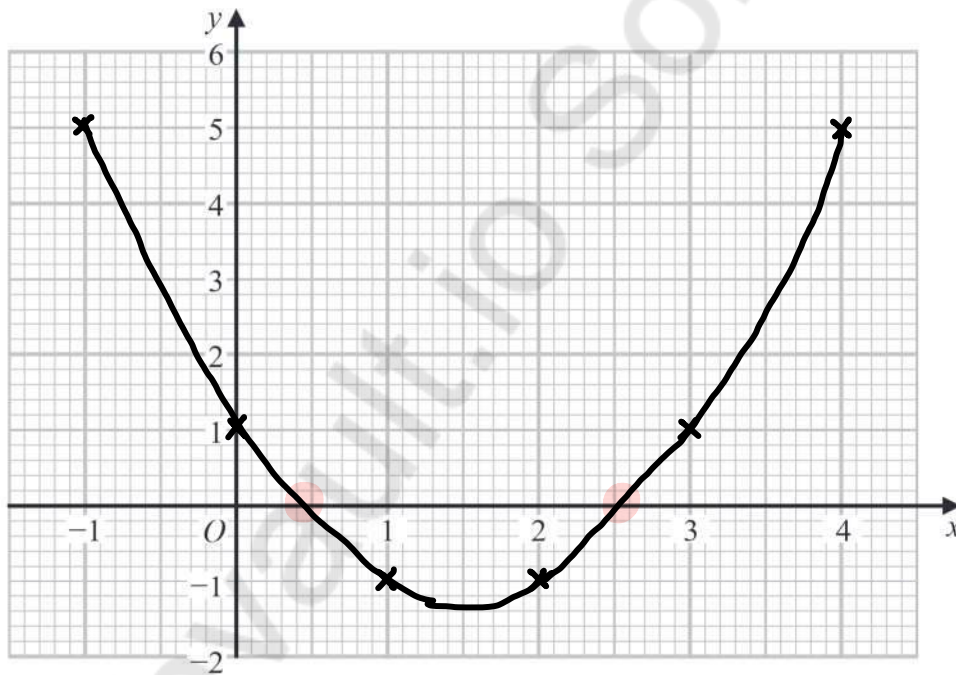

(2)

- (c) Using your graph, find estimates for the solutions of the equation $x^2 - 3x + 1 = 0$

0.4 and 2.5

(2)

(Total for Question 6 is 6 marks)



DO NOT WRITE IN THIS AREA

DO NOT WRITE IN THIS AREA

DO NOT WRITE IN THIS AREA

7 Here are two cubes, A and B.

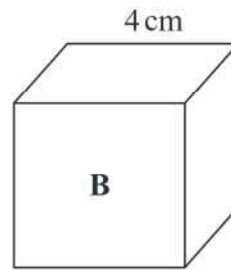
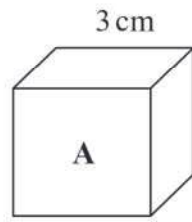

Cube A has a mass of 81 g.

Cube B has a mass of 128 g.

Work out

the density of cube A : the density of cube B

Give your answer in the form $a : b$, where a and b are integers.

$\frac{m}{V}$

Cube A

$$\text{mass} = 81\text{g}$$

$$\begin{aligned} \text{Volume} &= l \times w \times h \\ &= 3 \times 3 \times 3 \\ &= 27\text{cm}^3 \end{aligned}$$

$$\begin{aligned} \text{Density} &= 81\text{g} \div 27\text{cm}^3 \\ &= 3\text{g/cm}^3 \end{aligned}$$

Cube B

$$\text{mass} = 128\text{g}$$

$$\begin{aligned} \text{Volume} &= 4 \times 4 \times 4 \\ &= 64\text{cm}^3 \end{aligned}$$

$$\begin{aligned} \text{Density} &= 128\text{g} \div 64\text{cm}^3 \\ &= 2\text{g/cm}^3 \end{aligned}$$

A : B
3 : 2

3 : 2

(Total for Question 7 is 3 marks)



8 The table shows the amount of snow, in cm, that fell each day for 30 days.

Amount of snow (s cm)	Frequency
$0 \leq s < 10$	8
$10 \leq s < 20$	10
$20 \leq s < 30$	7
$30 \leq s < 40$	2
$40 \leq s < 50$	3

midpoints	midpoints \times frequency
5	40
15	150
25	175
35	70
45	135
	<hr/> 570

Work out an estimate for the mean amount of snow per day.

$$\frac{570}{30} = \frac{57}{3} = 19$$

..... 19 cm

(Total for Question 8 is 3 marks)



DO NOT WRITE IN THIS AREA

DO NOT WRITE IN THIS AREA

DO NOT WRITE IN THIS AREA

- 9 A cube is placed on top of a cuboid, as shown in the diagram, to form a solid.

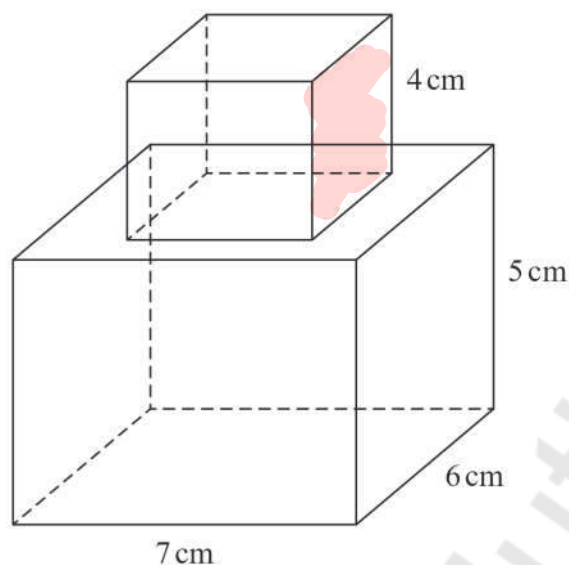

The cube has edges of length 4 cm.

The cuboid has dimensions 7 cm by 6 cm by 5 cm.

Work out the total surface area of the solid.

$$\begin{aligned} \text{S.A. of cube} &= 4 \times 4 = 16 \text{ cm}^2 \\ &= 16 \times 5 = 80 \text{ cm}^2 \end{aligned}$$

S.A. of cuboid =

$$\text{Front + Back} = (7 \times 5) \times 2 = 70 \text{ cm}^2$$

$$\text{Left + Right} = (5 \times 6) \times 2 = 60 \text{ cm}^2$$

$$\text{Bottom} = 7 \times 6 = 42 \text{ cm}^2$$

$$\begin{array}{r} \text{Top} = 7 \times 6 = 42 - 16 = 26 \text{ cm}^2 \quad 172 \\ \hline 198 \text{ cm}^2 \quad 26 \end{array}$$

$$80 + 198 = 278 \text{ cm}^2$$

..... **278** cm²

(Total for Question 9 is 3 marks)



- 10 The table shows some information about the profit made each day at a cricket club on 100 days.

Profit (£ x)	Frequency
$0 \leq x < 50$	10
$50 \leq x < 100$	15
$100 \leq x < 150$	25
$150 \leq x < 200$	30
$200 \leq x < 250$	5
$250 \leq x < 300$	15

↓ +
↓ +
↓ +
↓ +

- (a) Complete the cumulative frequency table.

Profit (£ x)	Cumulative frequency
$0 \leq x < 50$	10
$0 \leq x < 100$	25
$0 \leq x < 150$	50
$0 \leq x < 200$	80
$0 \leq x < 250$	85
$0 \leq x < 300$	100

(50, 10)

(1)



(b) On the grid, draw a cumulative frequency graph for this information.

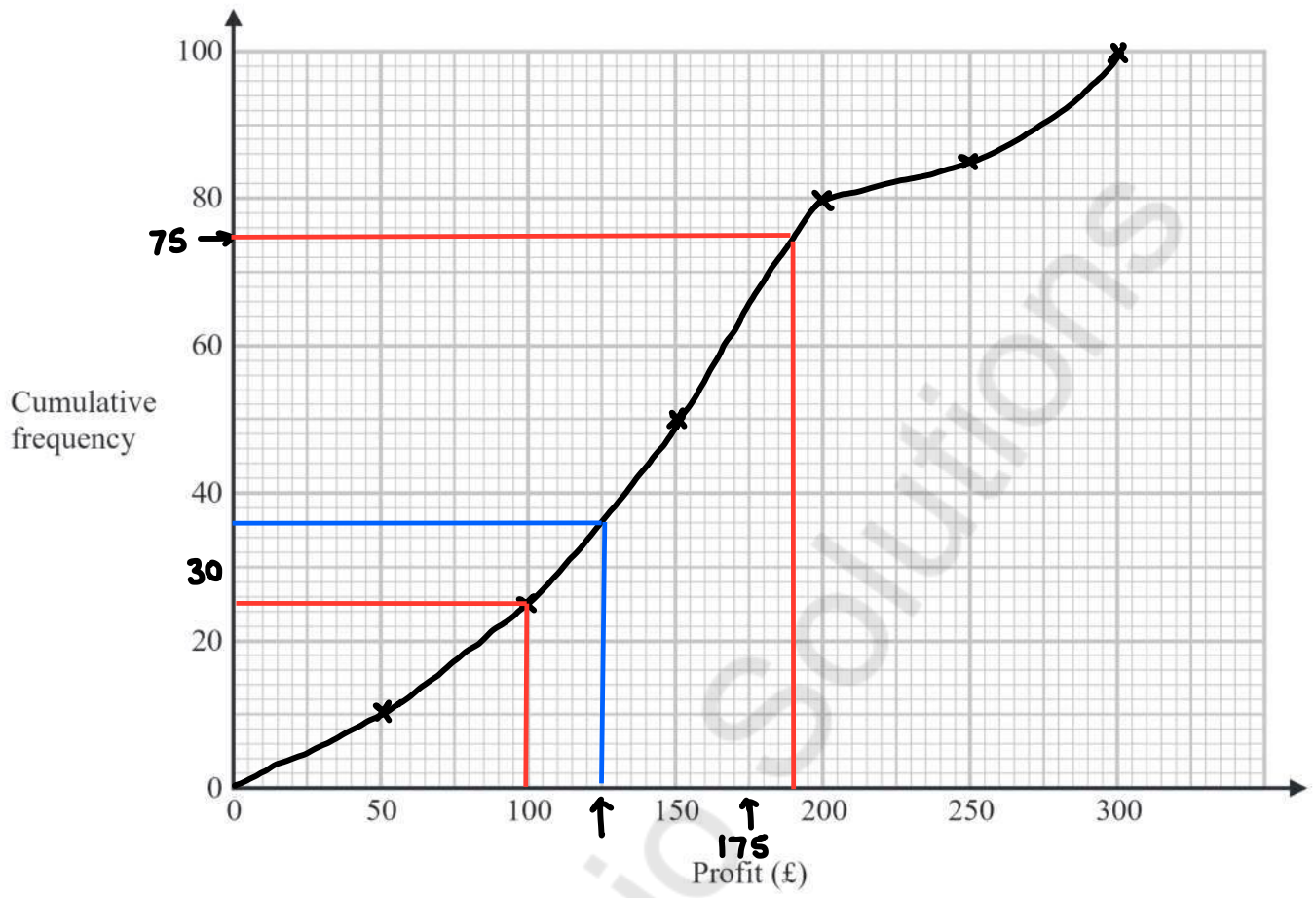

(2)

(c) Use your graph to find an estimate for the number of days on which the profit was less than £125

..... **36** days
(1)

(d) Use your graph to find an estimate for the interquartile range.

$$\begin{aligned}
 IQR &= UQ - LQ \\
 &= 190 - 100 \\
 &= 90
 \end{aligned}$$

£ **90**
(2)

(Total for Question 10 is 6 marks)

DO NOT WRITE IN THIS AREA

DO NOT WRITE IN THIS AREA

DO NOT WRITE IN THIS AREA



- 11 Cormac has some sweets in a bag.
The sweets are lime flavoured or strawberry flavoured or orange flavoured.

In the bag

$$\begin{array}{l} \text{number of lime} \\ \text{flavoured sweets} \end{array} : \begin{array}{l} \text{number of strawberry} \\ \text{flavoured sweets} \end{array} : \begin{array}{l} \text{number of orange} \\ \text{flavoured sweets} \end{array} = 9 : 4 : x$$

Cormac is going to take at random a sweet from the bag.

The probability that he takes a lime flavoured sweet is $\frac{3}{7}$

Work out the value of x .

$$L : S : O$$

$$9 : 4 : x = \begin{array}{l} 9 + 4 + x \text{ parts} \\ 13 + x \text{ parts} \end{array}$$

$$\frac{9}{13+x} = \frac{3}{7}$$

$$63 = 3(13+x)$$

$$\begin{array}{r} 63 = 39 + 3x \\ -39 \quad -39 \end{array}$$

$$\begin{array}{r} 24 = 3x \\ \div 3 \quad \div 3 \\ 8 = x \end{array}$$

$$x = \underline{8}$$

(Total for Question 11 is 3 marks)



- 12 Express $0.1\dot{1}\dot{7}$ as a fraction.
You must show all your working.

$$x = 0.1\dot{1}\dot{7}$$

$$10x = 1.\dot{1}\dot{7}$$

$$100x = 11.\dot{7}\dot{1}$$

$$1000x = 117.\dot{1}\dot{7}$$

$$\begin{array}{r} 1000x = 117.\dot{1}\dot{7} \\ - 10x = 1.\dot{1}\dot{7} \\ \hline \end{array}$$

$$990x = 116$$

$$\div 990$$

$$\div 990$$

$$x = \frac{116}{990}$$

$$\frac{116}{990}$$

(Total for Question 12 is 3 marks)



- 13 A right-angled triangle is formed by the diameters of three semicircular regions, A, B and C as shown in the diagram.

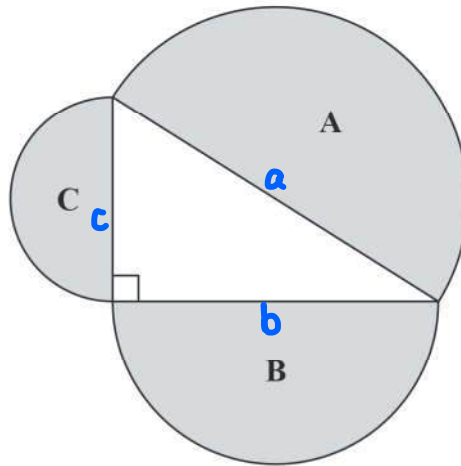

Show that

area of region A = area of region B + area of region C

$$b^2 + c^2 = a^2$$

$$\text{Area of A} = \frac{\pi r^2}{2} = \frac{\pi \left(\frac{a}{2}\right)^2}{2} = \frac{1}{8} a^2 \pi$$

$$\text{Area of B} = \frac{\pi \left(\frac{b}{2}\right)^2}{2} = \frac{1}{8} b^2 \pi$$

$$\text{Area of C} = \frac{\pi \left(\frac{c}{2}\right)^2}{2} = \frac{1}{8} c^2 \pi$$

$$\frac{1}{8} a^2 \pi = \frac{1}{8} b^2 \pi + \frac{1}{8} c^2 \pi$$

$$a^2 \pi = b^2 \pi + c^2 \pi$$

$$a^2 = b^2 + c^2$$

(Total for Question 13 is 3 marks)



DO NOT WRITE IN THIS AREA

DO NOT WRITE IN THIS AREA

DO NOT WRITE IN THIS AREA

14 Here is a speed-time graph.

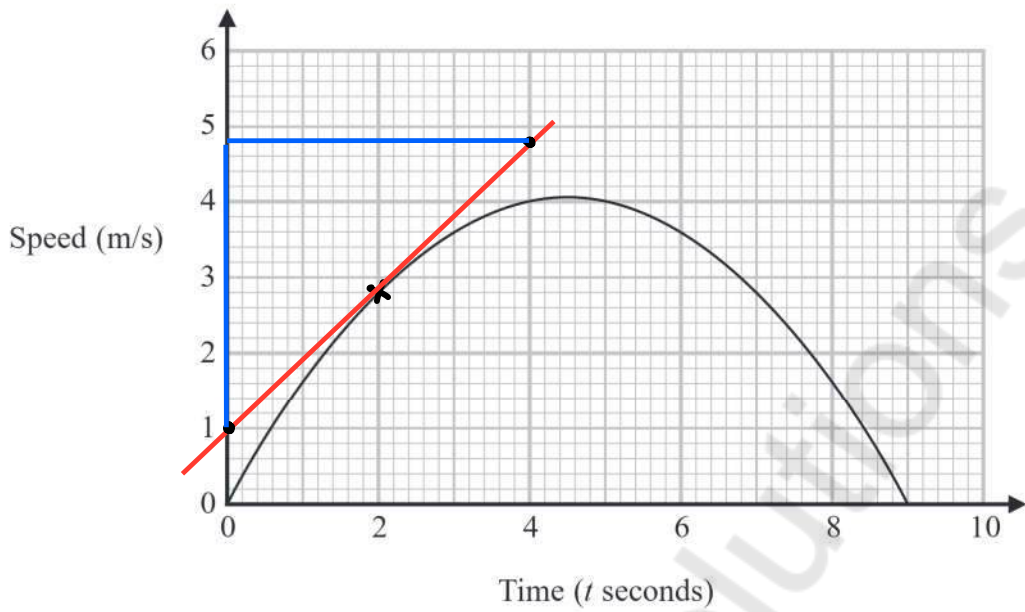

(a) Work out an estimate of the gradient of the graph at $t = 2$

$$\text{gradient} = \frac{\text{change in } y}{\text{change in } x} = \frac{3.8}{4} = 0.95$$

$$\begin{array}{r} 0.95 \\ 4 \overline{) 3.820} \end{array}$$

0.95

(3)

(b) What does the area under the graph represent?

The distance travelled

(1)

(Total for Question 14 is 4 marks)



P 6 6 3 0 5 A 0 1 5 2 4

15 A , B and C are three points such that

$$\vec{AB} = 3\mathbf{a} + 4\mathbf{b}$$

$$\vec{AC} = 15\mathbf{a} + 20\mathbf{b}$$

(a) Prove that A , B and C lie on a straight line.

$$\vec{AC} = 5(3\mathbf{a} + 4\mathbf{b})$$

$$\vec{AC} = 5\vec{AB}$$

(2)

D , E and F are three points on a straight line such that

$$\vec{DE} = 3\mathbf{e} + 6\mathbf{f}$$

$$\vec{EF} = -10.5\mathbf{e} - 21\mathbf{f}$$

(b) Find the ratio

length of DF : length of DE

$$\vec{DF} = \vec{DE} + \vec{EF}$$

$$= 3\mathbf{e} + 6\mathbf{f} + (-10.5\mathbf{e} - 21\mathbf{f})$$

$$= -7.5\mathbf{e} - 15\mathbf{f}$$

$$= -7.5(\mathbf{e} + 2\mathbf{f}) \quad \text{length} > 0$$

$$\vec{DF} = 7.5(\mathbf{e} + 2\mathbf{f})$$

$$DF : DE$$

$$7.5(\mathbf{e} + 2\mathbf{f}) : 3\mathbf{e} + 6\mathbf{f}$$

$$7.5(\mathbf{e} + 2\mathbf{f}) : 3(\mathbf{e} + 2\mathbf{f})$$

$$\times 2 \quad 7.5 : 3$$

$$15 : 6$$

 $\times 2$

$$5 : 2$$

$$5 : 2$$

(3)

(Total for Question 15 is 5 marks)



DO NOT WRITE IN THIS AREA

DO NOT WRITE IN THIS AREA

DO NOT WRITE IN THIS AREA

16 A first aid test has two parts, a theory test and a practical test.
 The probability of passing the theory test is 0.75
 The probability of passing only one of the two parts is 0.36
 The two events are independent.

Work out the probability of passing the practical test.

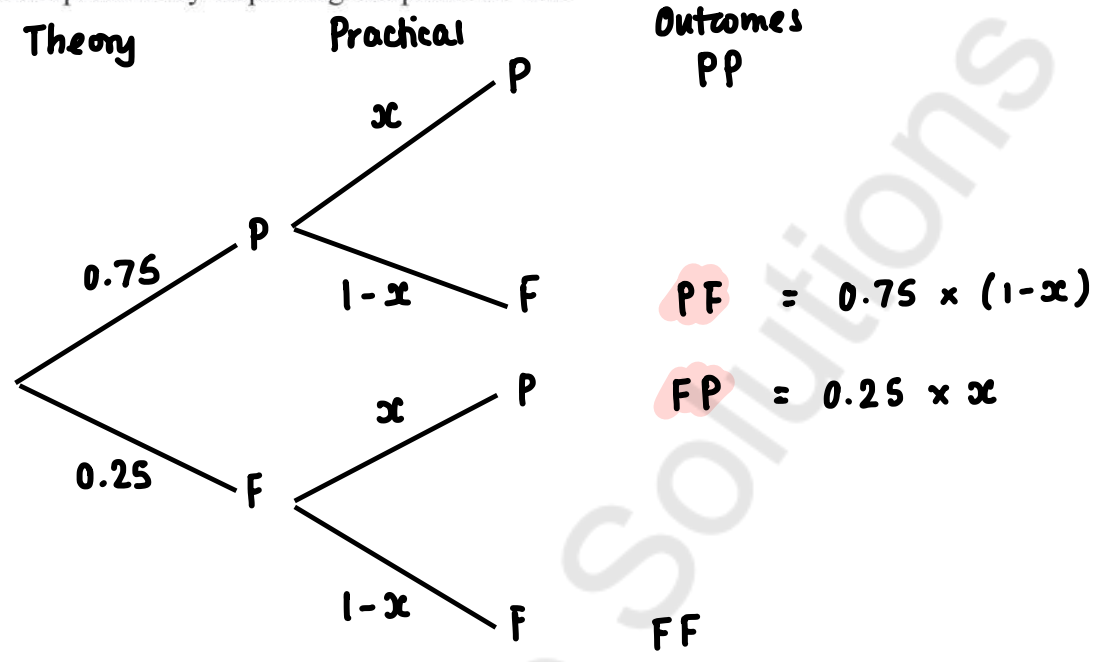

$$0.75(1-x) + 0.25x = 0.36$$

$$0.75 - 0.75x + 0.25x = 0.36$$

$$0.75 - 0.5x = 0.36$$

$$-0.75 \quad -0.75$$

$$-0.5x = -0.39$$

$$\div -0.5 \quad \div -0.5$$

$$x = 0.78$$

0.78

(Total for Question 16 is 4 marks)



- 17 y is directly proportional to the square root of t .
 $y = 15$ when $t = 9$

t is inversely proportional to the cube of x .
 $t = 8$ when $x = 2$

Find a formula for y in terms of x .
 Give your answer in its simplest form.

$$y \propto \sqrt{t}$$

$$y = k\sqrt{t} \quad \longleftrightarrow \quad y = 5\sqrt{t}$$

$$15 = k\sqrt{9}$$

$$15 = 3k \quad \div 3$$

$$5 = k$$

$$t \propto \frac{1}{x^3}$$

$$t = \frac{a}{x^3} \quad \longleftrightarrow \quad t = \frac{64}{x^3}$$

$$8 = \frac{a}{(2)^3}$$

$$8 = \frac{a}{8} \quad \times 8$$

$$64 = a$$

$$y = 5\sqrt{\frac{64}{x^3}}$$

$$y = 5\left(\frac{8}{\sqrt{x^3}}\right)$$

$$y = \frac{40}{\sqrt{x^3}}$$

$$y = \frac{40}{\sqrt{x^3}}$$

(Total for Question 17 is 4 marks)



DO NOT WRITE IN THIS AREA

DO NOT WRITE IN THIS AREA

DO NOT WRITE IN THIS AREA

18 Work out the value of $\frac{\left(5\frac{4}{9}\right)^{-\frac{1}{2}} \times \left(4\frac{2}{3}\right)}{2^{-3}}$

You must show all your working.

$$\begin{aligned} & \left(5\frac{4}{9}\right)^{-\frac{1}{2}} \\ = & \left(\frac{49}{9}\right)^{-\frac{1}{2}} \\ = & \left(\frac{9}{49}\right)^{\frac{1}{2}} \\ = & \sqrt{\frac{9}{49}} \\ = & \frac{3}{7} \end{aligned}$$

$$\frac{\frac{3}{7} \times 4\frac{2}{3}}{2^{-3}}$$

$$\frac{\frac{3}{7} \times \frac{14}{3}}{\frac{1}{8}}$$

$$\frac{\frac{42}{21}}{\frac{1}{8}}$$

$$\frac{2}{\frac{1}{8}}$$

$$2 \div \frac{1}{8}$$

$$2 \times \frac{8}{1}$$

$$= 16$$

$$2^{-3} = \frac{1}{2^3} = \frac{1}{8}$$

16

(Total for Question 18 is 4 marks)

MathsVale.io Solutions



19 Solve $\frac{1}{2x-1} + \frac{3}{x-1} = 1$

Give your answer in the form $\frac{p \pm \sqrt{q}}{2}$ where p and q are integers.

$$\frac{1(x-1) + 3(2x-1)}{(2x-1)(x-1)} = 1$$

$$\frac{x-1 + 6x-3}{(2x-1)(x-1)} = 1$$

$$\frac{7x-4}{(2x-1)(x-1)} = 1$$

$$\times (2x-1)(x-1) \quad \times (2x-1)(x-1)$$

$$7x-4 = (2x-1)(x-1)$$

$$7x-4 = 2x^2 - 2x - x + 1$$

$$7x-4 = 2x^2 - 3x + 1$$

$$-7x + 4 \quad -7x + 4$$

$$0 = 2x^2 - 10x + 5$$

$$a = 2 \quad b = -10 \quad c = 5$$

$$x = \frac{-b \pm \sqrt{b^2 - 4ac}}{2a}$$

$$x = \frac{-(-10) \pm \sqrt{(-10)^2 - 4(2)(5)}}{2(2)}$$

$$= \frac{10 \pm \sqrt{100 - 40}}{4}$$

$$= \frac{10 \pm \sqrt{60}}{4}$$

$$\begin{aligned} \sqrt{60} &= \sqrt{4\sqrt{15}} \\ &= 2\sqrt{15} \end{aligned}$$

$$\frac{10 \pm 2\sqrt{15}}{4} \div 2$$

$$\frac{5 \pm \sqrt{15}}{2}$$

$$\frac{5 \pm \sqrt{15}}{2}$$

(Total for Question 19 is 4 marks)



20 The centre of a circle is the point with coordinates $(-1, 3)$

The point A with coordinates $(6, 8)$ lies on the circle.

Find an equation of the tangent to the circle at A .

Give your answer in the form $ax + by + c = 0$ where a , b and c are integers.

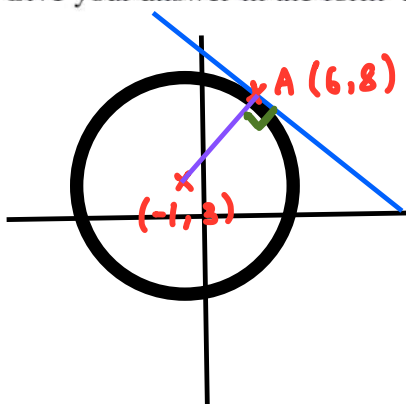

Gradient of radius

$$= \frac{y_2 - y_1}{x_2 - x_1} \quad \begin{matrix} (-1, 3) \\ x_1, y_1 \end{matrix} \text{ and } \begin{matrix} (6, 8) \\ x_2, y_2 \end{matrix}$$

$$= \frac{8 - 3}{6 - (-1)}$$

$$= \frac{5}{7}$$

Gradient of tangent = perpendicular to radius

$$= -\frac{7}{5}$$

$$y = mx + c \quad m = -\frac{7}{5} \quad \begin{matrix} (6, 8) \\ x, y \end{matrix}$$

$$8 = -\frac{7}{5}(6) + c$$

$$8 = -\frac{42}{5} + c$$

$$+\frac{42}{5} \quad +\frac{42}{5}$$

$$\frac{40}{5} + \frac{42}{5} = c$$

$$\frac{82}{5} = c$$

$$y = -\frac{7}{5}x + \frac{82}{5}$$

$$5y = -7x + 82$$

$$+7x - 82 + 7x - 82$$

$$7x + 5y - 82 = 0$$

$$7x + 5y - 82 = 0$$

(Total for Question 20 is 4 marks)



21 The diagram shows three circles, each of radius 4 cm.

The centres of the circles are A , B and C such that ABC is a straight line and $AB = BC = 4$ cm.

$$r = 4 \text{ cm}$$

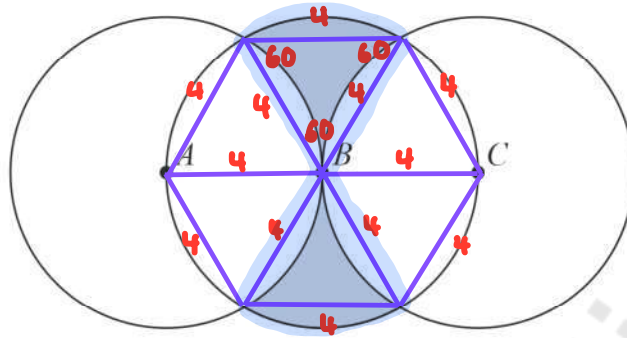

Work out the total area of the two shaded regions.
Give your answer in terms of π

$$\text{Area of shaded region} = \text{Area of 2 sectors} - 4 \text{ segments}$$

$$\text{Area of segment} = \text{Area of sector} - \text{Area of triangle}$$

$$\begin{aligned} \text{Area of sector} &= \frac{\theta}{360} \times \pi r^2 \\ &= \frac{60}{360} \times \pi (4)^2 \\ &= \frac{1}{6} \times 16\pi \\ &= \frac{16}{6}\pi \\ &= \frac{8}{3}\pi \text{ cm}^2 \end{aligned}$$

$$\begin{aligned} \text{Area of segment} \\ &= \frac{8}{3}\pi - 4\sqrt{3} \end{aligned}$$

$$\begin{aligned} \text{Area of triangle} &= \frac{1}{2} ab \sin C \\ &= \frac{1}{2} \times 4 \times 4 \times \sin(60) \\ &= 8 \times \frac{\sqrt{3}}{2} \\ &= \frac{8\sqrt{3}}{2} = 4\sqrt{3} \text{ cm}^2 \end{aligned}$$

$$\begin{aligned} \text{Area of shaded regions} \\ &= 2 \left(\frac{8}{3}\pi \right) - 4 \left(\frac{8}{3}\pi - 4\sqrt{3} \right) \\ &= \frac{16}{3}\pi - \frac{32}{3}\pi + 16\sqrt{3} \\ &= -\frac{16}{3}\pi + 16\sqrt{3} \end{aligned}$$

$$\underline{\underline{-\frac{16}{3}\pi + 16\sqrt{3} \text{ cm}^2}}$$

(Total for Question 21 is 5 marks)

TOTAL FOR PAPER IS 80 MARKS



DO NOT WRITE IN THIS AREA

DO NOT WRITE IN THIS AREA

DO NOT WRITE IN THIS AREA

Mathvault.io Solutions

BLANK PAGE



P 6 6 3 0 5 A 0 2 3 2 4

DO NOT WRITE IN THIS AREA

DO NOT WRITE IN THIS AREA

DO NOT WRITE IN THIS AREA

Mathvault.io Solutions

BLANK PAGE

