

Surname	Centre Number	Candidate Number
Other Names		0



**GCSE – NEW**

3300U30-1



A16-3300U30-1

**MATHEMATICS  
UNIT 1: NON-CALCULATOR  
INTERMEDIATE TIER**

TUESDAY, 8 NOVEMBER 2016 – MORNING

1 hour 45 minutes

**ADDITIONAL MATERIALS**

The use of a calculator is not permitted in this examination.  
A ruler, protractor and a pair of compasses may be required.

**INSTRUCTIONS TO CANDIDATES**

Use black ink or black ball-point pen. Do not use gel pen or correction fluid.

You may use a pencil for graphs and diagrams only.

Write your name, centre number and candidate number in the spaces at the top of this page.

Answer **all** the questions in the spaces provided.

If you run out of space, use the continuation page at the back of the booklet, taking care to number the question(s) correctly.

Take  $\pi$  as 3.14.

**INFORMATION FOR CANDIDATES**

You should give details of your method of solution when appropriate.

Unless stated, diagrams are not drawn to scale.

Scale drawing solutions will not be acceptable where you are asked to calculate.

The number of marks is given in brackets at the end of each question or part-question.

In question 6, the assessment will take into account the quality of your linguistic and mathematical organisation, communication and accuracy in writing.

For Examiner's use only		
Question	Maximum Mark	Mark Awarded
1.	6	
2.	3	
3.	3	
4.	6	
5.	5	
6.	7	
7.	5	
8.	3	
9.	3	
10.	6	
11.	7	
12.	3	
13.	4	
14.	4	
15.	5	
16.	6	
17.	4	
<b>Total</b>	<b>80</b>	



NOV163300U30101

## Formula List – Intermediate Tier

Area of trapezium =  $\frac{1}{2}(a + b)h$

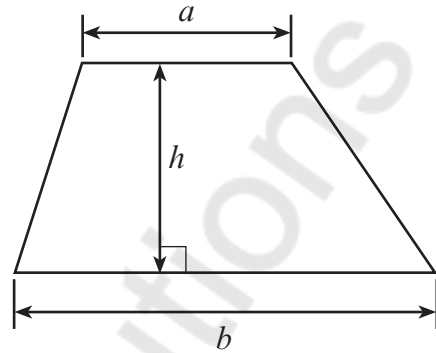

Volume of prism = area of cross-section  $\times$  length

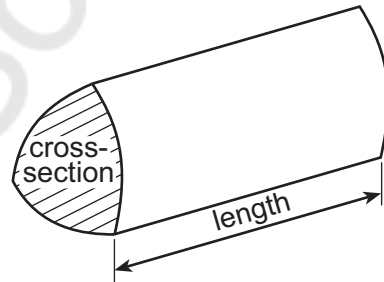

1. Calculate each of the following.

(a)  $0.4 \times 0.7$  [1]

$$4 \times 7 = 28$$

$$0.4 \times 0.7 = 0.28$$

(b)  $13.8 - 7.45$  [1]

$$\begin{array}{r} 0.13.810 \\ - 7.45 \\ \hline \end{array}$$

$$- 7.45$$

$$\underline{\underline{6.35}}$$

(c)  $3^3 - 2^4$  [2]

$$3^3 = 3 \times 3 \times 3 = 27$$

$$27$$

$$2^4 = 2 \times 2 \times 2 \times 2 = 16$$

$$-16$$

$$\underline{\underline{11}}$$

(d)  $\frac{9}{10} - \frac{3}{5}$  [2]

$$\frac{9}{10} - \frac{3 \times 2}{5 \times 2}$$

$$\frac{9}{10} - \frac{6}{10} = \frac{9-6}{10} = \underline{\underline{\frac{3}{10}}}$$



2. Circle either TRUE or FALSE for each of the following statements.

[3]

$100\% = 70$ $10\% = 7$ $20\% = 14$ 20% of 70 is the same as 70% of 20.	$100\% = 20$ $10\% = 2$ $70\% = 14$	TRUE	FALSE
$\frac{1}{2} \times \frac{1}{8} = \frac{1 \times 1}{2 \times 8} = \frac{1}{16}$ $\frac{1}{2}$ of $\frac{1}{8}$ is the same as $\frac{1}{8}$ of $\frac{1}{2}$	$\frac{1}{8} \times \frac{1}{2} = \frac{1 \times 1}{8 \times 2} = \frac{1}{16}$	TRUE	FALSE
Let the number be $x$ A number is halved. The answer is halved, and then this answer is halved again. This gives the same answer as dividing the original number by 6.	$\frac{1}{2}x \times \frac{1}{2} \times \frac{1}{2} = \frac{x}{8}$ $\frac{x}{6} \neq \frac{x}{8}$	TRUE	FALSE
Let number be $x$ Dividing a number by 15 is the same as first dividing by 10 and then dividing the answer by 5.	$\frac{x}{10} \times \frac{1}{5} = \frac{x}{50}$ $\frac{x}{50} \neq \frac{x}{15}$	TRUE	FALSE
Let number be $x$ Multiplying a number by 2.5 is the same as first multiplying by 10 and then dividing the answer by 4.	$x \times 2.5 = 2.5x$ $\frac{x \times 10}{4} = \frac{10}{4}x = \frac{5}{2}x = 2.5x$	TRUE	FALSE

Space for working:

.....

.....

.....

.....

.....

.....

.....

.....



3. A shop has 31 plant pots.  
Some are blue, some are yellow and the rest are red.  
There are five more blue pots than yellow pots.  
There are four times as many blue pots as there are red pots.

Calculate how many pots there are of each colour.

[3]

$$\text{Blue} = B \quad \text{Yellow} = y \quad \text{Red} = R$$

$$B = y + 5 \quad 4R = y + 5 \quad 4R - y = 5 \quad \text{--- (1)}$$

$$B = 4 \times R = 4R \quad + 5R + y = 31 \quad \text{--- (2)}$$

$$B + y + R = 31$$

$$\frac{9R}{9} = \frac{36}{9}$$

$$4R + y + R = 31$$

$$R = 4$$

$$4R + R + y = 31$$

$$B = 4 \times 4 = 16$$

$$5R + y = 31$$

$$y = B - 5, \quad y = 16 - 5 = 11$$

Blue 16      Yellow 11      Red 4

4. (a) Write down the next two numbers in the following sequence.

[2]

$$\begin{array}{r} 283 \\ -26 \\ \hline 07 \end{array}$$

$$33 \xrightarrow{-7} 26 \xrightarrow{-7} 19 \xrightarrow{-7} 12 \quad \quad \quad 5 \xrightarrow{-7} -2$$

- (b) Simplify the expression  $10g - 5f - 3g + 3f$ .

[2]

$$10g - 3g - 5f + 3f = \underline{\underline{7g - 2f}}$$

- (c) Using the formula  $2T = M + 3K$ , find the value of  $K$  when  $T = 11$  and  $M = 4$ .

[2]

$$2 \times 11 = 4 + 3K$$

$$22 = 4 + 3K$$

$$-4 \quad -4$$

$$\frac{18}{3} = \frac{3K}{3}$$

$$\underline{\underline{6 = K}}$$



5. Three **red** cards have the following numbers written on them.



Four **green** cards have the following numbers written on them.

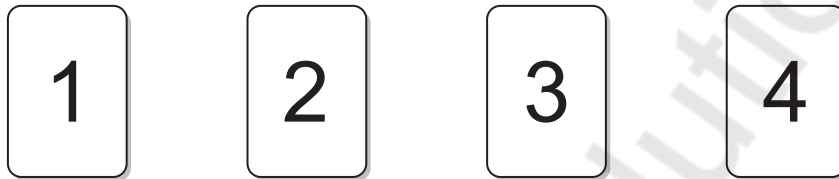

In a game, the cards are turned face down.  
A player chooses one red card and one green card at random.  
The player's score is the sum of the two numbers.

- (a) Complete the following table.

[1]

		Score			
Red card	9	10	11	12	13
	6	7	8	9	10
	3	4	5	6	7
		1	2	3	4
		Green card			

- (b) A player wins a prize if the score is **more** than 9.  
Safira plays the game once. What is the probability that she wins a prize?

[2]

$$\frac{5}{12}$$

- (c) 60 people play the game once.  
Approximately how many people would you expect to win a prize?

[2]

$$\frac{5}{12} \times 60 = 5 \times 5 = \underline{\underline{25 \text{ people}}}$$



6. In this question, you will be assessed on the quality of your organisation, communication and accuracy in writing.

A right-angled triangle  $BCD$  is joined to a rectangle  $ABDE$ , as shown below.

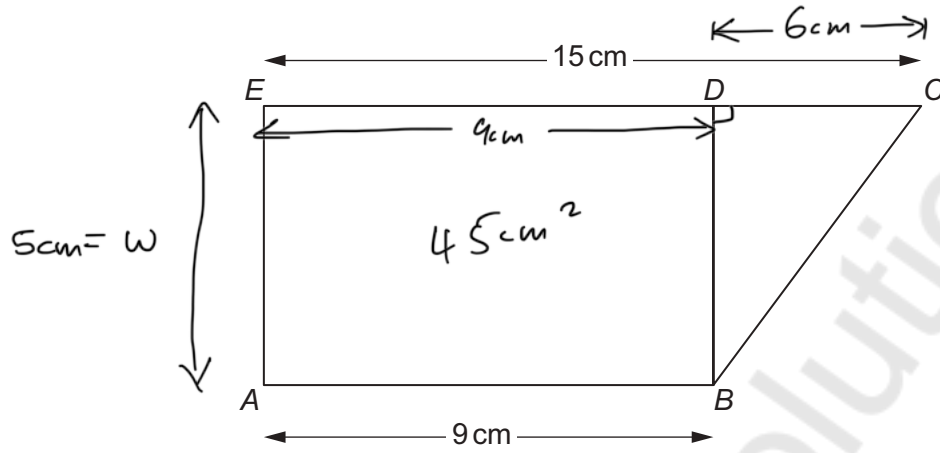

Diagram not drawn to scale

The area of the rectangle is  $45\text{ cm}^2$ .

Calculate the area of the right-angled triangle.  
You must show your working.

[5 + 2 OCW]

$$w \times 9 = 45$$

$$w = \frac{45}{9}$$

$$w = 5\text{ cm}$$

$$DC = 15 - 9 = 6\text{ cm}$$

$$\begin{aligned} \text{Area of triangle} &= \frac{1}{2} \times 6 \times h \\ &= \frac{1}{2} \times 6 \times 5 \end{aligned}$$

$$\text{Area of triangle} = \underline{\underline{15\text{ cm}^2}}$$



7. Solve each of the following equations.

$$(a) \frac{w}{5} = 10$$

$$\times 5 \quad \times 5$$

[1]

$$w = 50$$

$$(b) \frac{42}{x} = 7$$

$$\times x \quad \times x$$

[1]

$$\frac{42}{7} = \frac{7x}{7}$$

$$6 = x$$

$$(c) 13y - 5 = 9y + 27$$

$$-9y \quad -9y$$

$$4y - 5 = 27$$

$$+5 \quad +5$$

$$\frac{4y}{4} = \frac{32}{4}$$

$$y = 8$$

[3]



8. Two types of number are added or multiplied together. Complete the table below to show whether the answer will be odd or even. One answer has been filled in for you. [3]

	Calculation:	Answer will be:
	even number + even number	even
$2 + 1 = 3$	even number + odd number	odd
$1 + 1 = 2$	odd number + odd number	even
$2 \times 2 = 4$	even number $\times$ even number	even
$3 \times 2 = 6$ $2 \times 1 = 2$	even number $\times$ odd number	even
$1 \times 1 = 1$ $3 \times 3 = 9$	odd number $\times$ odd number	odd



9. Write down five numbers that satisfy all of the following conditions:

- They are all between 1 and 9 inclusive.
- They have a median value of 6.
- They have a range of 7.
- Their mean is 5.

[3]

Possibilities with range of 7: 2 9, 1 8

$$1 + 6 + 8 = 15$$

$$15 + x = 25$$

$$x = 10$$

$$7 + 3 = 10$$

1
---

3
---

6
---

7
---

8
---



10. A regular polygon has exterior angles of  $45^\circ$ .

(a) How many sides does this polygon have? [2]

$$\begin{array}{l} \text{Sum of exterior angles} = 360 \\ \text{One exterior angle} = \frac{360}{n} \\ 45 = \frac{360}{n} \end{array} \quad \left| \quad \begin{array}{l} 45n = 360 \div 9 = \frac{40}{5} = 8 \\ n = 8 \text{ sides} \end{array} \right.$$

(b) Each side of this regular polygon is 7 cm.  
A sketch of two sides,  $AB$  and  $BC$ , of the polygon is shown below.

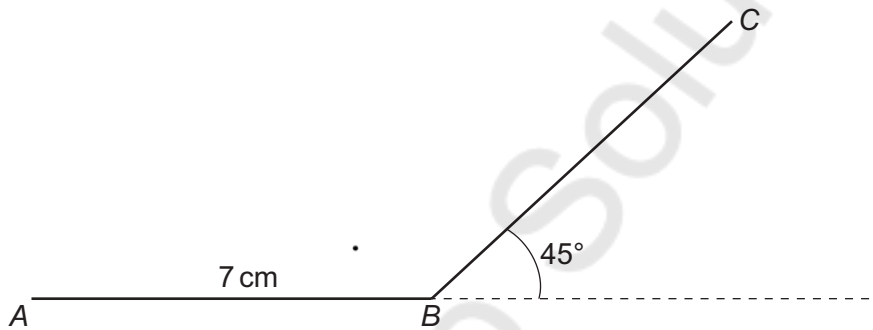
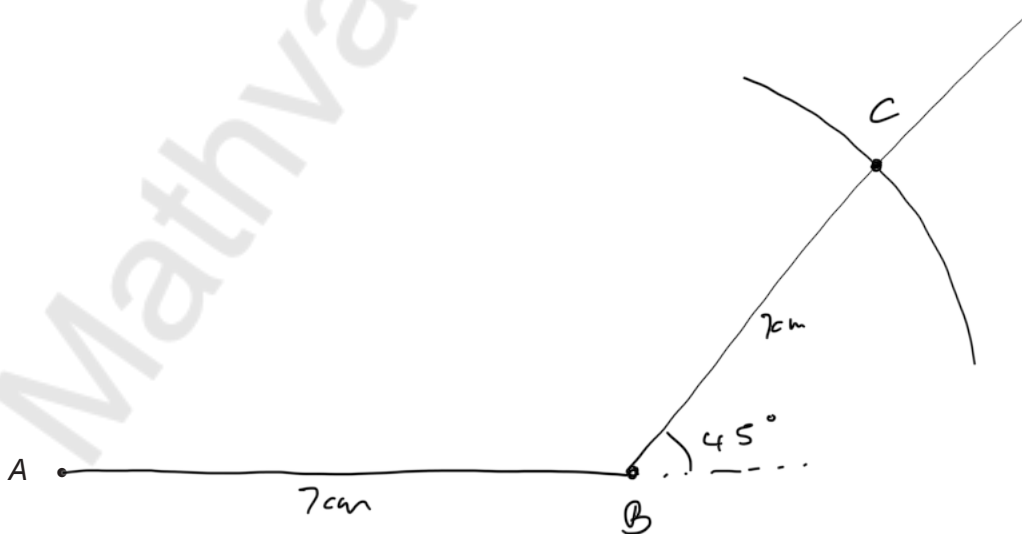

Diagram not drawn to scale

Using only a ruler and a pair of compasses, construct an accurate drawing that shows these **two sides** of the polygon.  
The point  $A$  has been given.  
You must show your construction arcs. [4]



11. (a) The table below shows some of the values of  $y = 2x^2 - 5x - 1$  for values of  $x$  from -2 to 4.

Complete the table by finding the value of  $y$  for  $x = -1$  and for  $x = 2$ .

[2]

$x$	-2	-1	0	1	2	3	4
$y = 2x^2 - 5x - 1$	17	6	-1	-4	-3	2	11

$$y = 2(-1)^2 - 5(-1) - 1$$

$$y = 2(2)^2 - 5(2) - 1$$

$$y = 2(1) + 5 - 1$$

$$y = 2(4) - 10 - 1$$

$$y = 2 + 5 - 1$$

$$y = 8 - 10 - 1$$

$$y = 6$$

$$y = -3$$

- (b) On the graph paper below, draw the graph of  $y = 2x^2 - 5x - 1$  for values of  $x$  from -2 to 4.

[2]

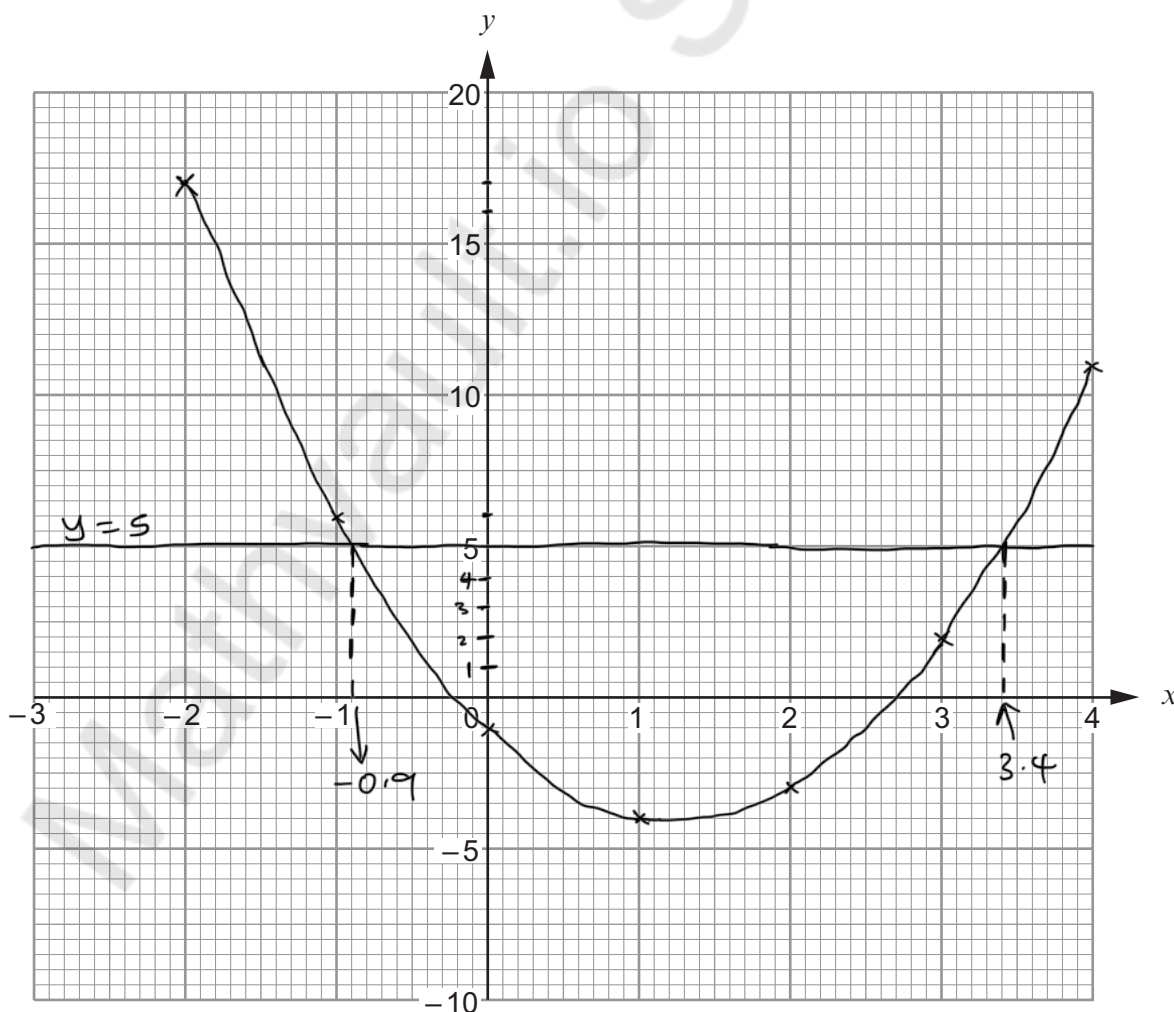

- (c) Draw the line  $y = 5$  on the graph paper.

Write down the values of  $x$  where the line  $y = 5$  cuts the curve  $y = 2x^2 - 5x - 1$ .  
Give your answers correct to 1 decimal place. [2]

Values of  $x$  are -0.9 and 3.4

- (d) Circle the equation below whose solutions are the values you have given in (c). [1]

$$2x^2 - 5x - 1 = 0$$

$$2x^2 - 5x - 6 = 0$$

$$2x^2 - 5x - 5 = 0$$

$$2x^2 - x - 1 = 0$$

$$2x^2 - 5x + 4 = 0$$

$$5 = 2x^2 - 5x - 1$$

$$0 = 2x^2 - 5x - 1 - 5$$

$$2x^2 - 5x - 6 = 0$$



12. A fair six-sided dice and a fair coin are thrown together once.

Circle the correct answer for each of the following statements.

(a) The number of possible outcomes is

[1]

2

6

8

12

24.

(b) The probability of getting a **4** on the dice and a **tail** on the coin is

[1]

 $\frac{1}{8}$  $\frac{1}{12}$  $\frac{1}{2}$  $\frac{1}{6}$  $\frac{1}{24}$ .

(c) The probability of getting a **multiple of 3** on the dice and a **head** on the coin is

[1]

 $\frac{1}{8}$  $\frac{1}{12}$  $\frac{1}{2}$  $\frac{1}{6}$  $\frac{1}{24}$ .

Space for working:

	1	2	3	4	5	6
H	1H	2H	3H	4H	5H	6H
T	1T	2T	3T	4T	5T	6T



13. (a) Make  $m$  the subject of the formula  $y = 6m + 7$ . [2]

$$\begin{aligned} y - 7 &= 6m \\ \frac{y - 7}{6} &= \frac{6m}{6} \\ m &= \frac{y - 7}{6} \end{aligned}$$

- (b) Factorise  $6x^2 - 12x$ . [2]

$$\underline{\underline{6x(x - 2)}}$$

14. Find, in standard form, the value of each of the following.

- (a)  $\frac{7.5 \times 10^6}{5000}$  [2]

$$\begin{aligned} \frac{7.5 \times 10^6}{5 \times 10^3} &= \frac{75 \times 10^5}{5 \times 10^3} \quad 10^5 \div 10^3 = 10^{5-3} = 10^2 \\ \frac{15}{5} \sqrt{7.5} & \quad \frac{15}{10} \times 10^2 \times 10^1 \\ & \quad \underline{\underline{1.5 \times 10^3}} \end{aligned}$$

- (b)  $(2.3 \times 10^3) + (6.4 \times 10^4)$  [2]

$$\begin{aligned} & \left( \frac{2.3 \times 10^3 \times 10^1}{10} \right) + (6.4 \times 10^4) \\ & (0.23 \times 10^4) + (6.4 \times 10^4) \\ & (0.23 + 6.4) \times 10^4 \\ & \underline{\underline{6.63 \times 10^4}} \end{aligned}$$



15. Each side of a square is of length  $(2x + 3y)$  cm.  
The perimeter of the square is 62 cm.

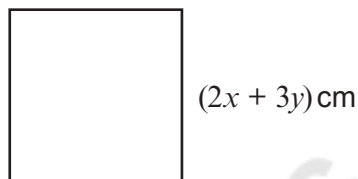

- Each side of a regular octagon is of length  $(x + 2y)$  cm.  
The perimeter of the octagon is 72 cm.

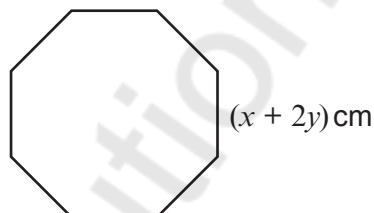

Use an algebraic method to find the value of  $x$  and the value of  $y$ .

[5]

$$4(2x + 3y) = 62$$

$$8(x + 2y) = 72$$

$$\frac{4(2x + 3y)}{4} = \frac{62}{4}$$

$$\frac{8(x + 2y)}{8} = \frac{72}{8}$$

$$2x + 3y = 15.5 \quad \text{--- (1)}$$

$$x + 2y = 9 \quad \text{--- (2)}$$

$$x + 2y = 9 \quad \text{--- (2)}$$

$$x = 9 - 2(2.5)$$

$$- \quad 4x + 6y = 31 \quad \text{--- (3)}$$

$$9x = 9 - 5$$

$$- \quad 4x + 8y = 36 \quad \text{--- (4)}$$

$$x = 4$$

$$2y = 5$$

$$y = 2.5$$

$$x = 4 \quad y = 2.5$$



16. Alwyn often drives from Bangor to Cardiff.  
He always chooses one of two routes for these journeys.  
He either travels through Rhayader or through Hereford.  
The probability that he travels through Rhayader is 0.7.

Sometimes he decides to stop for a break during his journey.  
His decision is independent of the route he takes.

The probability that he travels through Rhayader **and** stops for a break is 0.42.

- (a) Complete the following tree diagram.

[4]

$$P(R) \times P(\text{stop}) = 0.42 \quad P(\text{stop}) = \frac{0.42}{0.7} \quad P(H) = 0.3$$

$$0.7 \times P(\text{stop}) = 0.42 \quad P(\text{stop}) = 0.6 \quad P(\text{not stop}) = 0.4$$

$$P(R) = 0.7$$

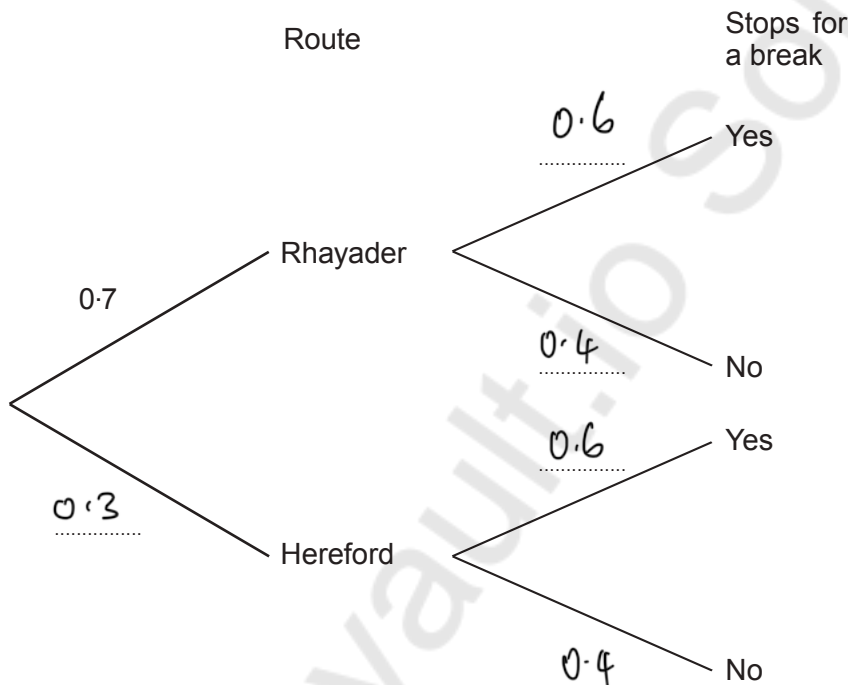

- (b) Calculate the probability that Alwyn travels through Hereford but **does not** stop for a break.

[2]

$$P(H \cap \text{no stop}) = P(H) \times P(\text{no stop})$$

$$= 0.3 \times 0.4$$

$$P(H \text{ and no stop}) = 0.12$$



17. William has  $n$  marbles.  
Lois had 4 times as many marbles as William, but she has now lost 23 of them.

Lois still has more marbles than William.

Write down an inequality in terms of  $n$  to show the above information.  
Use your inequality to find the least number of marbles that William may have. [4]

$$L = 4n$$

$$W = n$$

$$\begin{array}{r} 4n - 23 > n \\ + 23 \quad + 23 \end{array}$$

$$\begin{array}{r} 4n > n + 23 \\ -n \quad -n \end{array}$$

$$\begin{array}{r} 3n > 23 \\ \hline 3 \quad 3 \end{array}$$

$$n > 7.\dot{3}$$

lowest possible integer value of  $n = \underline{\underline{8}}$

END OF PAPER



**BLANK PAGE**

**PLEASE DO NOT WRITE  
ON THIS PAGE**

Mathvaudio Solutions



Question number	Additional page, if required. Write the question number(s) in the left-hand margin.
	<p>Mathsvault.io Solutions</p>

Examiner only

