

Surname	Centre Number	Candidate Number
Other Names		0



GCSE – NEW

3300U40-1



**MATHEMATICS
UNIT 2: CALCULATOR-ALLOWED
INTERMEDIATE TIER**

THURSDAY, 10 NOVEMBER 2016 – MORNING

1 hour 45 minutes

ADDITIONAL MATERIALS

A calculator will be required for this paper.
A ruler, a protractor and a pair of compasses may be required.

INSTRUCTIONS TO CANDIDATES

Use black ink or black ball-point pen. Do not use gel pen or correction fluid.
You may use a pencil for graphs and diagrams only.
Write your name, centre number and candidate number in the spaces at the top of this page.
Answer **all** the questions in the spaces provided.
If you run out of space, use the continuation page at the back of the booklet, taking care to number the question(s) correctly.
Take π as 3.14 or use the π button on your calculator.

INFORMATION FOR CANDIDATES

You should give details of your method of solution when appropriate.
Unless stated, diagrams are not drawn to scale.
Scale drawing solutions will not be acceptable where you are asked to calculate.
The number of marks is given in brackets at the end of each question or part-question.
In question 9, the assessment will take into account the quality of your linguistic and mathematical organisation, communication and accuracy in writing.

For Examiner's use only		
Question	Maximum Mark	Mark Awarded
1.	4	
2.	3	
3.	3	
4.	5	
5.	3	
6.	3	
7.	4	
8.	2	
9.	6	
10.	6	
11.	7	
12.	3	
13.	4	
14.	6	
15.	5	
16.	4	
17.	5	
18.	7	
Total	80	



NOV163300U40101

Formula List – Intermediate Tier

Area of trapezium $= \frac{1}{2} (a + b)h$

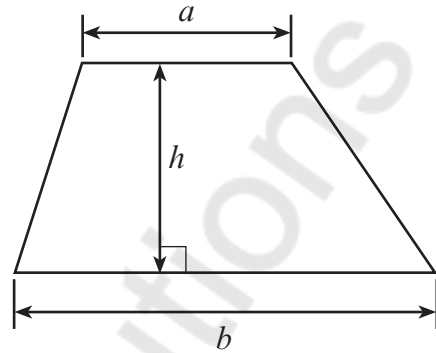

Volume of prism = area of cross-section \times length

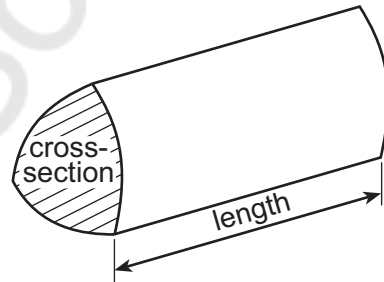

1. Using only the numbers in the following list,

57 58 59 60 61 62 63 64 65

write down

(a) a prime number, [1]

59

(b) a cube number, [1]

$1^3 = 1$ $2^3 = 8$ $3^3 = 27$ $4^3 = \underline{64}$

(c) a factor of 186, [1]

$186 \div 62 = 3$ hence 62 is a factor of 186

(d) a multiple of 7.25. [1]

$58 \div 7.25 = 8$ hence 58 is a multiple of 7.25

2. Circle the correct answer for each of the following statements.

(a) One angle in a right-angled triangle is 60° .
One of the other angles must be

180°

30°

120°

60°

360°

[1]

$180 - 60 - 90 = 30^\circ$

(b) Three of the angles in a quadrilateral add up to 250° .
The size of the fourth angle is

70°

360°

180°

110°

125.5°

[1]

$360 - 250 = 110$

(c) Huw is facing North.
He turns **clockwise** until he is facing West.
He has turned through an angle of

270°

3°

90°

0.75°

9°

[1]

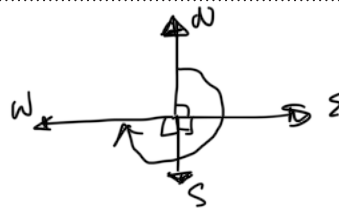

90×3

270



3. Shade the least number of squares in the lower two quadrants so that the grid has rotational symmetry of order 2. [3]

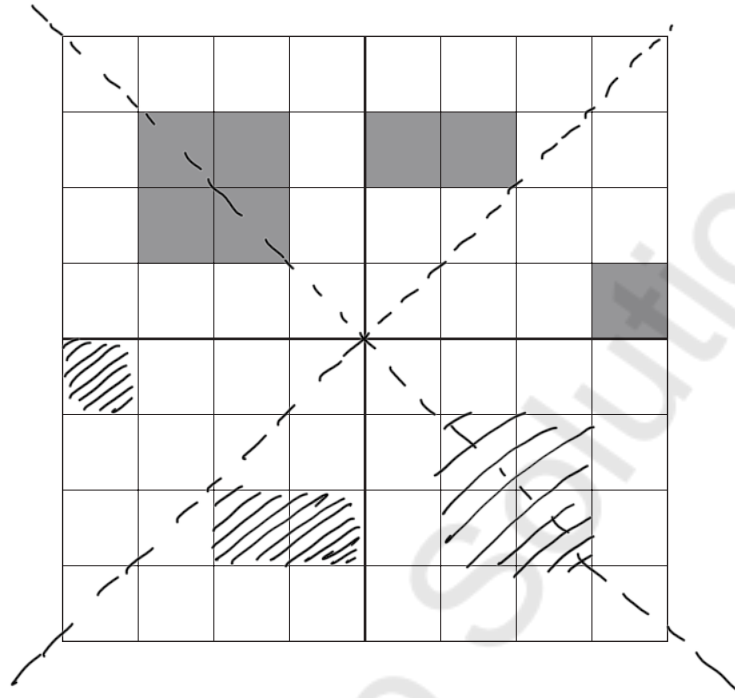

4. (a) Solve the equation $3x - 2 = 10$. [2]

$$+2 \quad +2$$

$$\frac{3x}{3} = \frac{12}{3}$$

$$\underline{x = 4}$$

(b) A number machine is shown below.

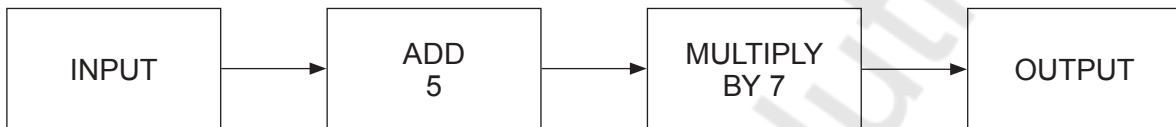

(i) Calculate the OUTPUT when the INPUT is -2 . [1]

$$-2 + 5 \times 7$$

$$3 \times 7 = 21$$

(ii) Write down an expression for the OUTPUT when the INPUT is n . [2]

$$(n + 5) \times 7$$

$$7(n + 5)$$



5. Complete each row of the following table.
The first row has been done for you.

[3]

Place	Temperature at midday	Change	Temperature at following midday
Holyhead	-1°C	Up 3°C	2°C
Dolgellau	-3°C	up 4°C	1°C
Cardigan	2°C	Down 3°C	-1°C
Newport	-4°C	Up 2°C	-2°C

- 6.

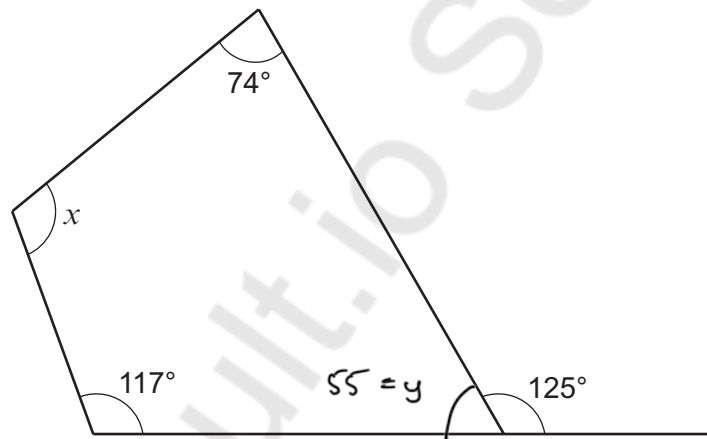

Diagram not drawn to scale

Find the size of angle x .

[3]

$$y + 125 = 180$$

$$y = 180 - 125$$

$$y = 55^{\circ}$$

$$360 = x + 117 + 74 + 55$$

$$360 = x + 246$$

$$-246 \quad -246$$

$$114^{\circ} = x$$

$$x = 114^{\circ}$$



7. Show clearly whether the following statement is true or false. [4]

'If you increase a positive number by 10% and then decrease that new value by 10%, you get back to your original number.'

let original number = x

$$100\% + 10\% = 110\%$$

$$110\% = \frac{110}{100} = 1.1$$

$$\text{New Value} = 1.1x$$

$$100\% - 10\% = 90\%$$

$$90\% = \frac{90}{100} = 0.9$$

After 10% decrease on

new value, we

$$\text{get } 0.9 \times 1.1x$$

$$0.99x$$

$$0.99x \neq x$$

hence the statement is false
as you do not get back to
your original number.

8. Circle either TRUE or FALSE for each statement given below. [2]

STATEMENT		
All equilateral triangles are congruent.	TRUE	FALSE
All squares with equal areas are congruent.	TRUE	FALSE
Circles with equal perimeters are congruent.	TRUE	FALSE
All regular octagons are congruent.	TRUE	FALSE



9. In this question, you will be assessed on the quality of your organisation, communication and accuracy in writing.

A square has a perimeter of 80 cm.

A circle fits exactly inside the square, as shown in the diagram.

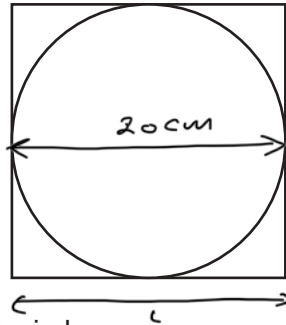

Calculate the circumference of the circle.

Give your answer correct to 1 decimal place.

You must show your working.

[4 + 2 OCW]

$$\frac{4l}{4} = \frac{80}{4}$$

$$\text{Diameter} = 20 \text{ cm}$$

$$l = 20 \text{ cm}$$

$$\text{Circumference} = \pi \times D$$

$$= \pi \times 20$$

$$\text{Circumference} = \underline{\underline{62.8 \text{ cm}}}$$



10. (a) Write down the n th term of the following sequence. [2]

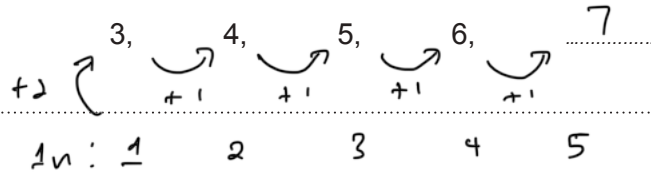

$$1n : \underline{1} \quad 2 \quad 3 \quad 4 \quad 5$$

$$n\text{th term} : \underline{1n + 2}$$

- (b) The n th term of a different sequence is given by $n^2 + 7$.

- (i) Write down the first three terms of this sequence. [2]

$$\text{1st term: } n=1, (1)^2 + 7 = 1 + 7 = 8$$

$$\text{2nd term: } n=2, (2)^2 + 7 = 4 + 7 = 11$$

$$\text{3rd term: } n=3, (3)^2 + 7 = 9 + 7 = 16$$

$$\text{1st term} = \underline{8} \quad \text{2nd term} = \underline{11} \quad \text{3rd term} = \underline{16}$$

- (ii) Which **term** in this sequence is the first that has a value greater than 85? [2]

$$n^2 + 7 > 85$$

This means when $n=9$ is the first value of $n^2 + 7$ that is greater than 85

$$n^2 > 78$$

$$n > 8.832 \text{ (3 d.p.)}$$

$$\text{Answer} = \underline{9} \text{ term.}$$



11. (a) Reflect the triangle S in the line $y = 2$.

[2]

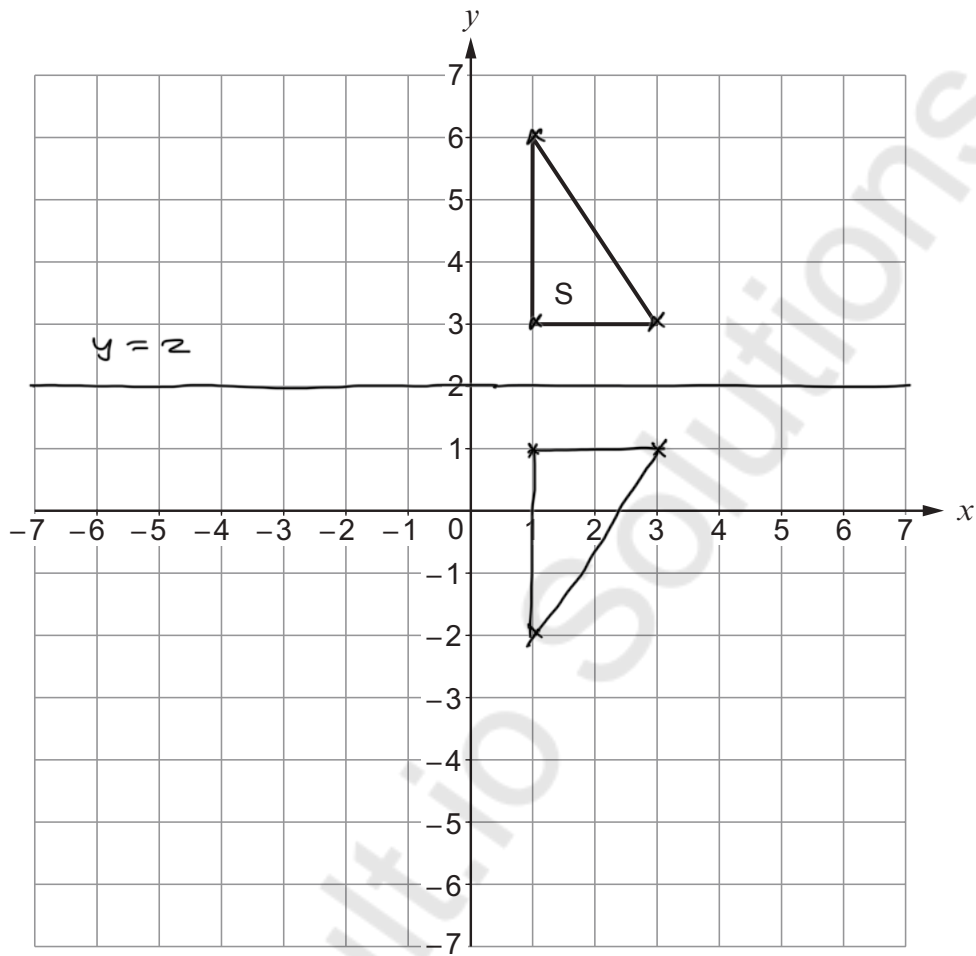

(b) Describe fully a single transformation that transforms triangle S onto triangle T. [3]

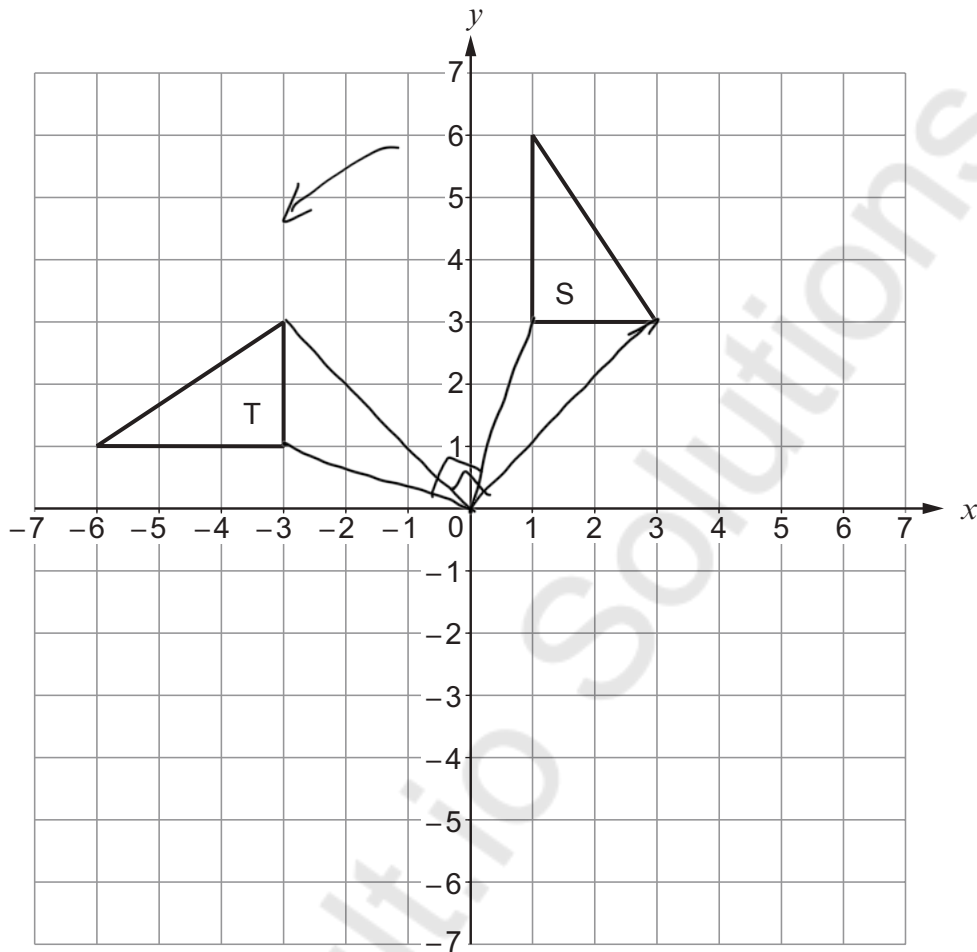

Ant! Clockwise rotation of 90° about the origin



- (c) (i) Translate the triangle S using the column vector $\begin{pmatrix} -5 \\ -4 \end{pmatrix}$.

[1]

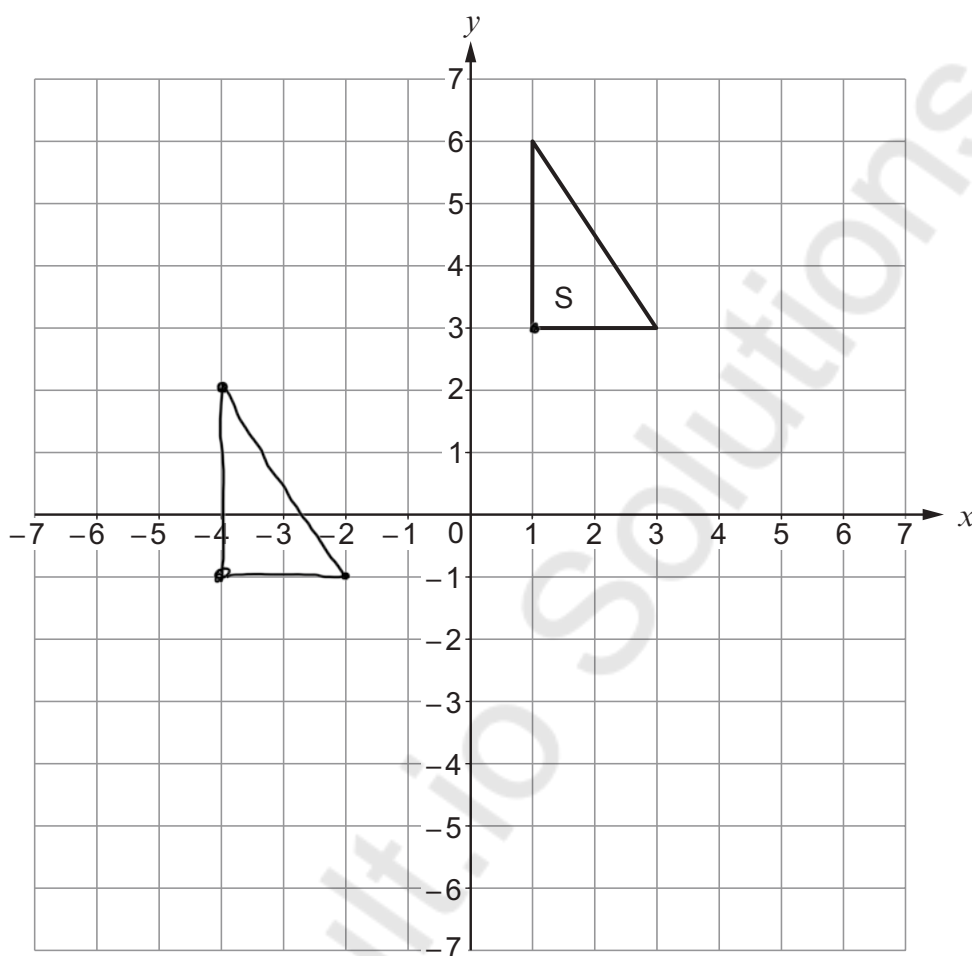
Examiner
only

- (ii) Write down the column vector that will reverse the translation in part (i).

[1]

$$\begin{pmatrix} 5 \\ 4 \end{pmatrix}$$



12. Circle the correct answer for each of the following.

(a) $x^3 \times x^6 =$

[1]

x^{36}

$x^{0.5}$

x^2

x^9

x^{18}

$$x^{2+6} = x^9$$

(b) $(7x - 5y) - (3x + 2y) =$

[1]

$4x - 3y$

$4x - 7y$

$4x + 3y$

$-4x + 7y$

$-4x - 7y$

$$7x - 5y - 3x - 2y$$

$$4x - 7y$$

$$7x - 3x - 5y - 2y$$

(c) A car travels x miles in 30 minutes.
Its average speed in miles per hour is

[1]

$\frac{x}{2}$

$\frac{x}{30}$

$2x$

$\frac{2}{x}$

$30x$

$$\frac{x}{0.5} = x \div 0.5 = \frac{x}{1} \div \frac{1}{2} = \frac{x}{1} \times \frac{2}{1} = 2x$$



13. A solution to the equation

$$2x^3 - 3x - 17 = 0$$

lies between 2 and 3.

Use the method of trial and improvement to find this solution correct to 1 decimal place.
You must show all your working.

[4]

x	$2x^3 - 3x - 17$	
2.0	-7	$x = 2.3$ to 1 d.p.
2.1	-4.778	
2.2	-2.304	
2.3	0.434	
2.4	3.448	

$$2.25 \leq x \leq 2.35$$

$$2.25 \quad -3.573$$

$$2.26 \quad -0.968$$

$$2.27 \quad -0.415$$

$$2.28 \quad -0.135$$

$$2.29 \quad 0.147$$



14. At a college, a total of 28 students study one or more of the science subjects: Biology, Chemistry and Physics.

The 28 students form the universal set, \mathcal{E} .

Some parts of the Venn diagram below have already been completed.

It is also known that:

- 5 students study only Biology
- 13 students study Chemistry

- (a) Complete the Venn diagram.

[3]

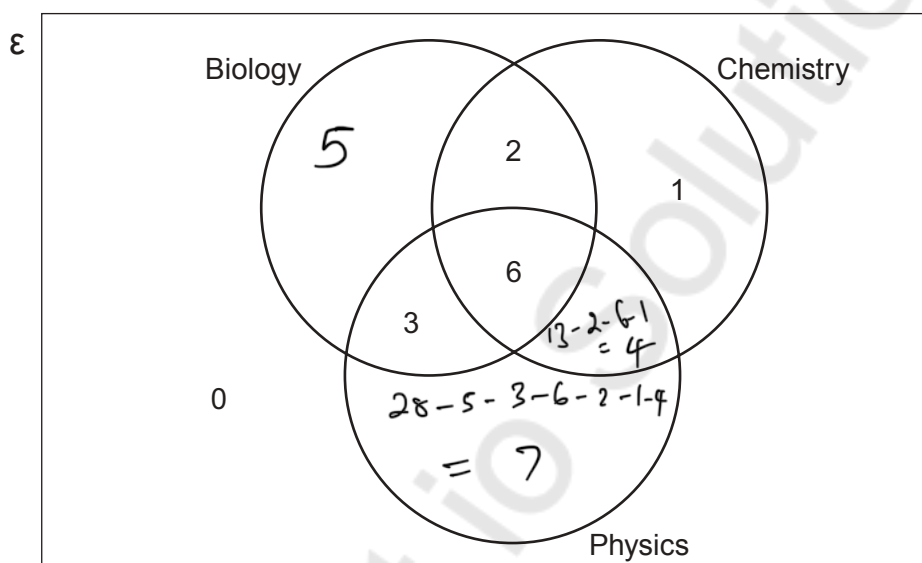

- (b) How many students study Biology and Chemistry but not Physics?

[1]

2 students

- (c) One of the students is chosen at random.
What is the probability that this student studies Biology?

[2]

$\frac{16}{28}$



15. (a) The diagram below shows the graph of a straight line for values of x from -3 to 3 .

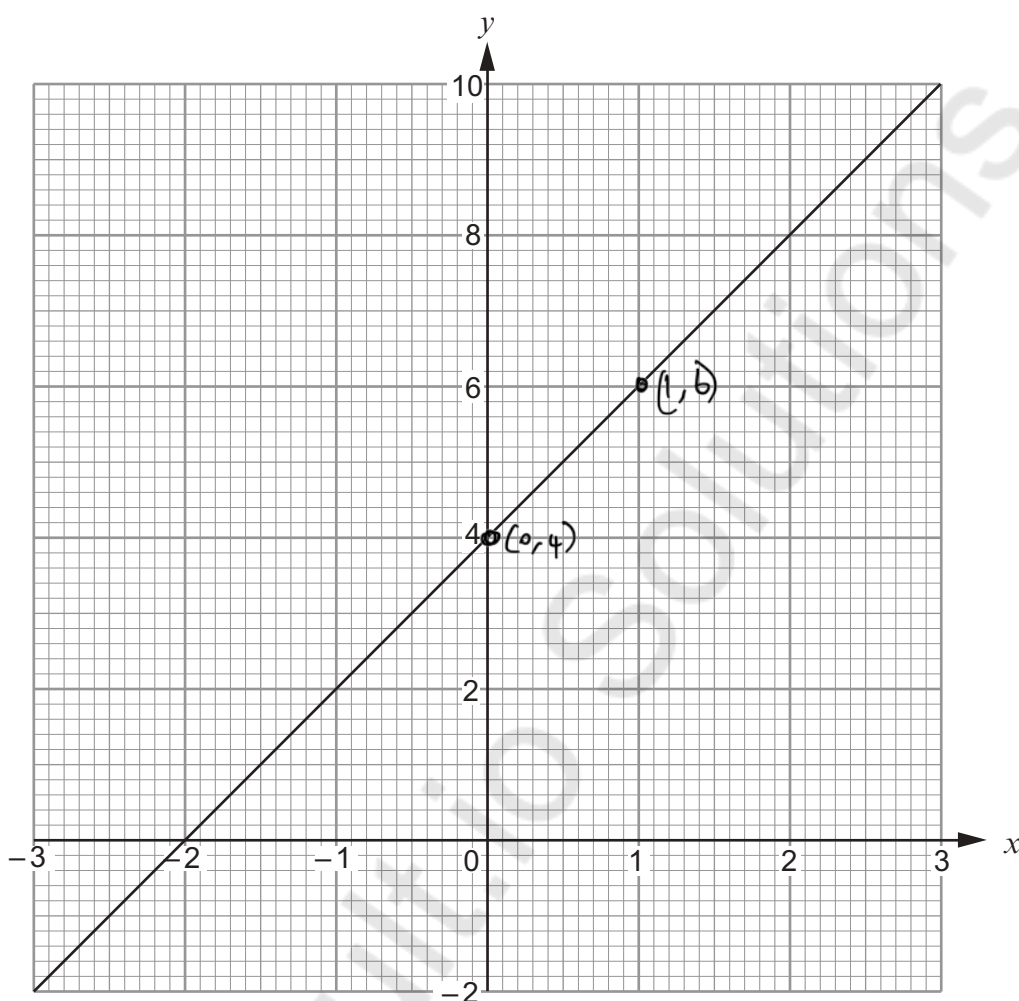

- (i) Write down the gradient of the above line. [1]

$$\frac{\text{change in } y}{\text{change in } x} = \frac{6-4}{1-0} = \frac{2}{1} = 2$$

- (ii) Write down the equation of the line in the form $y = mx + c$, where m and c are whole numbers. [2]

$$c = 4 \quad y = 2x + 4$$

- (b) Without drawing, show that the line $2y = 5x - 3$ is parallel to the line $4y = 10x + 7$. You must show working to support your answer. [2]

$$\frac{2y}{2} = \frac{5x}{2} - \frac{3}{2}$$

$$\frac{4y}{4} = \frac{10x}{4} + \frac{7}{4}$$

$$y = 2.5x - 1.5$$

$$y = 2.5x + 1.75$$

gradient for both lines are equal hence the lines are parallel



16. A factory uses a machine to produce electrical sockets. The manager carries out a survey to investigate the probability of the machine producing a defective socket.

The relative frequency of defective sockets produced was calculated after testing a total of 1000, 2000, 3000, 4000 and 5000 sockets.

The results are plotted on the graph below.

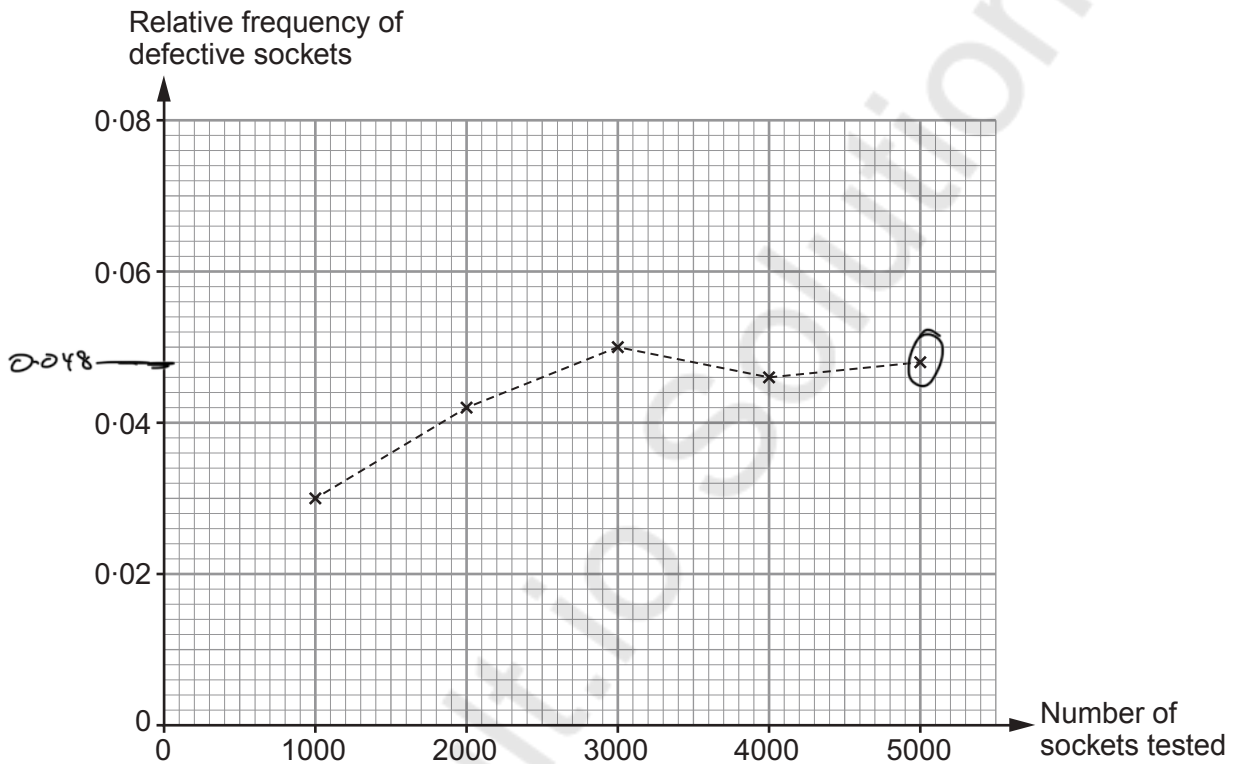

- (a) How many of the first 3000 sockets tested were defective? [2]

$$0.05 \times 300 = 150 \text{ were defective}$$

- (b) Write down the best estimate for the probability that one socket, selected at random, will be defective. You must give a reason for your choice. [2]

Probability: 0.048

Reason: At the last data point all of the sockets have been tested.



17. Points A , B , C and D lie on the circumference of a circle, centre O .
 BD is a diameter of the circle.
 The straight line $BC = 4.7$ cm and $\hat{BAC} = 28^\circ$.

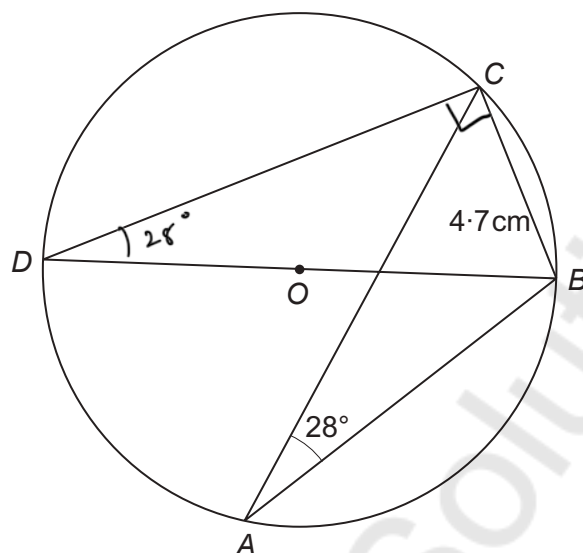

Diagram not drawn to scale

Write down the size of \hat{BDC} .
 Hence, calculate the length BD .
 You must show all your working.

[5]

$$\hat{BDC} = 28^\circ \text{ (Angle in same line segment are equal)}$$

$$\hat{BCD} = 90^\circ \text{ (Angle at circumference in a semi-circle = } 90^\circ \text{)}$$

$$\hat{CBD} = 180 - 90 - 28 = 62^\circ \text{ (Sum of angles in a triangle = } 180 \text{)}$$

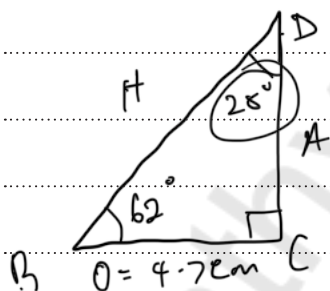

$$\begin{array}{ccc} \text{SOH} & \text{CAH} & \text{TOA} \\ \downarrow \downarrow & \downarrow & \downarrow \\ \sin \theta = \frac{O}{H} & & \end{array}$$

$$\sin 28 = \frac{4.7}{BD}$$

$$BD = \frac{4.7}{\sin 28}$$

$$BD = 10.0 \text{ cm (1 d.p.)}$$



18. (a) Factorise $x^2 - 2x - 24$, and hence solve $x^2 - 2x - 24 = 0$.

[3]

$$\begin{array}{l}
 1x - 24 = -24 \\
 \quad 1, -24 \\
 \quad 2, -12 \\
 \quad 3, -8 \\
 \quad \boxed{4, -6} \\
 \\
 x^2 - 2x - 24 \\
 \quad \swarrow \searrow \\
 x^2 + 4x - 6x - 24 \\
 x(x+4) - 6(x+4)
 \end{array}
 \quad
 \begin{array}{l}
 (x+4)(x-6) \\
 x^2 - 2x - 24 = 0 \\
 (x+4)(x-6) = 0 \\
 x+4 = 0 \quad x-6 = 0 \\
 \underline{x = -4} \quad \underline{x = 6}
 \end{array}$$

- (b) Solve the equation $\frac{4x-3}{2} + \frac{7x+1}{6} = \frac{29}{2}$.

[4]

$$\begin{aligned}
 6 \left[\frac{4x-3}{2} \right] + 6 \left[\frac{7x+1}{6} \right] &= 6 \left[\frac{29}{2} \right] \\
 3(4x-3) + 7x+1 &= 3(29) \\
 12x - 9 + 7x + 1 &= 87 \\
 12x + 7x &= 87 + 9 - 1 \\
 \frac{19x}{19} &= \frac{95}{19} \\
 \underline{\underline{x = 5}}
 \end{aligned}$$

END OF PAPER



Question number	Additional page, if required. Write the question number(s) in the left-hand margin.
	<p>Mathsvault.io Solutions</p>

Examiner only

