

Surname	Centre Number	Candidate Number
Other Names		0



**GCSE**

3300U30-1



**MATHEMATICS  
UNIT 1: NON-CALCULATOR  
INTERMEDIATE TIER**

MONDAY, 12 NOVEMBER 2018 – MORNING

1 hour 45 minutes

**ADDITIONAL MATERIALS**

The use of a calculator is not permitted in this examination.  
A ruler, protractor and a pair of compasses may be required.

**INSTRUCTIONS TO CANDIDATES**

Use black ink or black ball-point pen. Do not use gel pen or correction fluid.

You may use a pencil for graphs and diagrams only.

Write your name, centre number and candidate number in the spaces at the top of this page.

Answer **all** the questions in the spaces provided.

If you run out of space, use the continuation page at the back of the booklet. Question numbers must be given for all work written on the continuation page.

Take  $\pi$  as 3.14.

**INFORMATION FOR CANDIDATES**

You should give details of your method of solution when appropriate.

Unless stated, diagrams are not drawn to scale.

Scale drawing solutions will not be acceptable where you are asked to calculate.

The number of marks is given in brackets at the end of each question or part-question.

In question 6, the assessment will take into account the quality of your linguistic and mathematical organisation, communication and accuracy in writing.

For Examiner's use only		
Question	Maximum Mark	Mark Awarded
1.	5	
2.	5	
3.	6	
4.	4	
5.	4	
6.	5	
7.	3	
8.	6	
9.	3	
10.	7	
11.	3	
12.	4	
13.	3	
14.	3	
15.	6	
16.	4	
17.	5	
18.	4	
<b>Total</b>	<b>80</b>	



NOV183300U30101

## Formula List – Intermediate Tier

**Area of trapezium** =  $\frac{1}{2}(a + b)h$

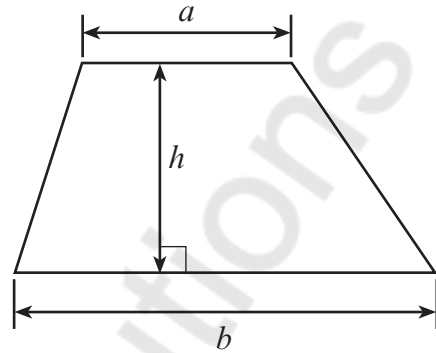

**Volume of prism** = area of cross-section  $\times$  length

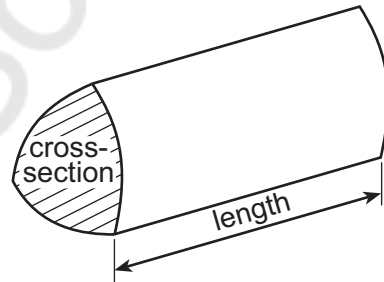

1. Consider the following list of numbers:

4 25 27 36 49 64 90 125

(a) Using only the numbers in the list above, write down

(i) the **three** cube numbers, [2]

27, 64 and 125

(ii) a number that is both a square number and a multiple of 9, [1]

36

(iii) a number that is a factor of 81. [1]

27

(b) Using **only two numbers from the list**, fill in the spaces in the following statement: [1]

'Dividing 125 by 4 and then rounding the answer to the nearest 10, gives an answer of 30.'

$$\frac{125}{4} = 28.5 \approx 30$$



2.

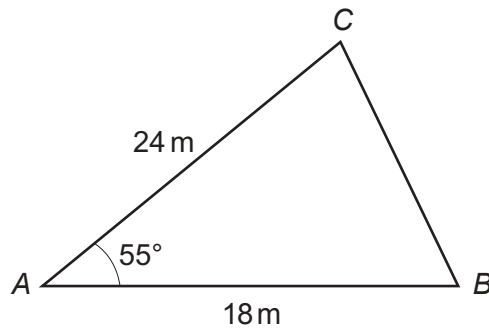

Diagram not drawn to scale

- (a) Draw an accurate scale drawing of the triangle shown above.  
Use the scale:

[3]

1 centimetre represents 3 metres.

$$AC = \frac{24}{3} = 8 \text{ cm}$$

$$AB = \frac{18}{3} = 6 \text{ cm}$$

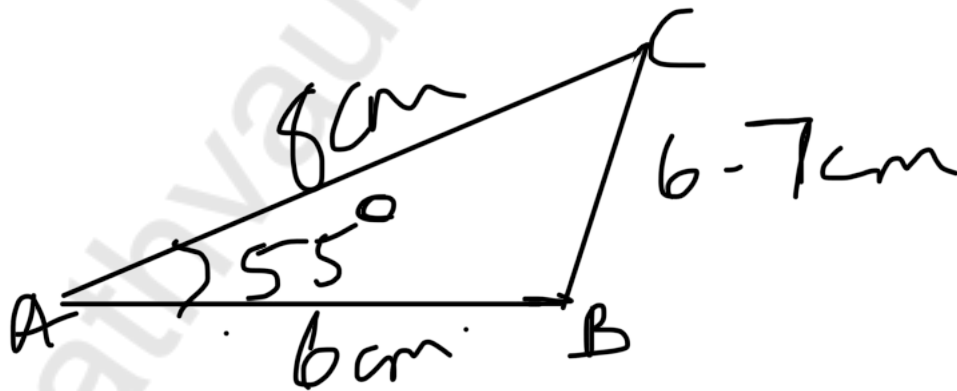

- (b) Use your scale drawing to calculate the **actual** length of side  $BC$ .  
Give your answer in metres. [2]

$$6.7 \times 3 = 20.1 \text{ m}$$

Actual length of  $BC$  = 20.1 metres

3. (a) Simplify the expression  $15x - 2y - 7x - 4y$ . [2]

$$15x - 7x - 2y - 4y = 8x - 6y = 2(4x - 3y)$$

- (b) Solve the equation  $2m - 7 = 12$ . [2]

$$2m - 7 = 12$$

$$2m = 12 + 7$$

$$2m = 19$$

$$m = 19/2 \text{ or } 9.5$$

- (c) Calculate the value of  $5f + 3g$  when  $f = -4$  and  $g = 7$ . [2]

$$5(-4) + 3(7) = -20 + 21 = 1$$



4. A triangle and a rectangle are shown below.

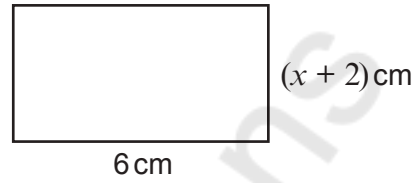
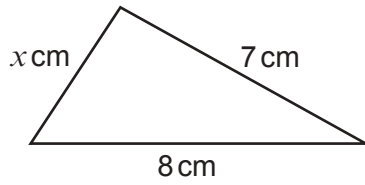

*Diagrams not drawn to scale*

The perimeter of the triangle is  $18$  cm.

Calculate the area of the rectangle.

[4]

$$x + 8 + 7 = 18$$

$$x + 15 = 18$$

$$x = 18 - 15 = 3 \text{ cm}$$

$$\begin{aligned} \text{A. of Rectangle} &= L \times W \\ &= 6 \times (3 + 2) \\ &= 30 \text{ cm}^2 \end{aligned}$$



5. (a) Estimate the answer to  $\frac{59 \times 301}{1997}$ .

You must show all your working.

[2]

$$\frac{300 \times 300}{2000} = 9$$

- (b) Given that  $341 \times 57 = 19\,437$ , write down the answer to each of the following.

(i)  $3.41 \times 5.7$

[1]

$$19.437 = 19.437$$

(ii)  $\frac{19\,437}{570}$

[1]

$$= \frac{341 \times 57}{57 \times 10} = 34.1$$



6. In this question, you will be assessed on the quality of your organisation, communication and accuracy in writing.

A box contains five identical balls numbered 1 to 5 respectively.  
One ball is chosen at random from the box.  
Its number is recorded and the ball is replaced in the box.

This process was carried out 75 times in total.

How many times would you expect an **even-numbered** ball to have been chosen?  
You must show all your working.

[3 + 2 OCW]

$$\text{Probability for 1 number to be chosen} = \frac{1}{5}$$

$$\text{Probability for even number to be chosen} = \frac{2}{5}$$

$$\text{Times even number was chosen} = \frac{2}{5} \times 75 = 30$$



7. (a)

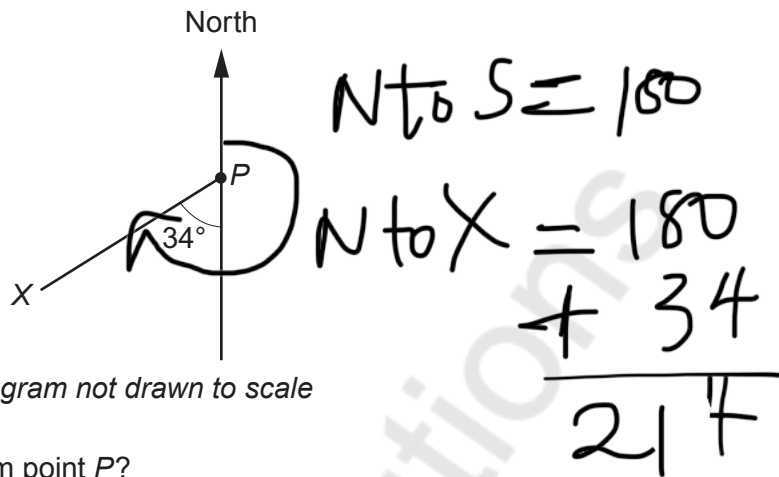

Diagram not drawn to scale

What is the bearing of X from point P?  
Circle the correct answer.

[1]

- 146°      326°      214°      034°      234°

(b) The diagram below shows 6 points on a map. The diagram is drawn to scale.

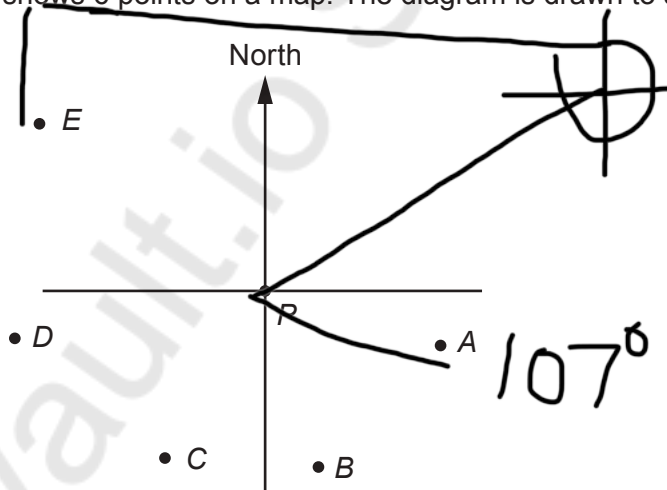

(i) A ship sails from point P on a bearing of 107°. It sails towards one of the five points A, B, C, D or E. Which of the five points is the ship sailing towards? Circle the correct answer.

[1]

- A      B      C      D      E

(ii) A second ship sails from point P for a number of miles on a bearing of 070°. It then changes direction and sails on a bearing of 270°. It is possible for the ship to reach **only one** of the five points A, B, C, D or E. Which point can the ship reach? Circle the correct answer.

[1]

- A      B      C      D      E



8.

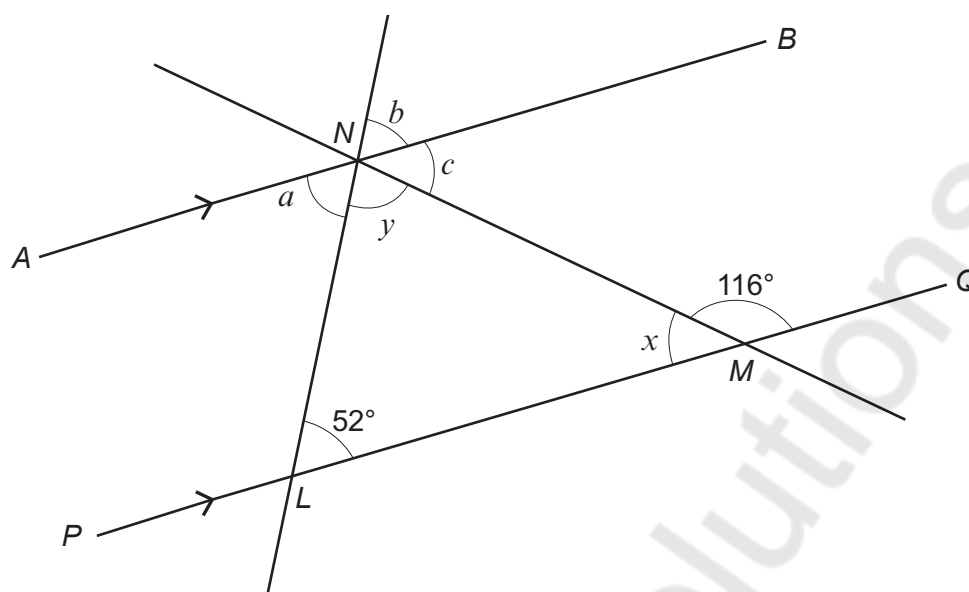

Diagram not drawn to scale

Line AB is parallel to line PQ.

(a) Find the size of each of the angles  $a$ ,  $b$  and  $c$ .

[3]

$$a = 52 \text{ (alternate)}$$

$$a = b = 52 \text{ (opposite)}$$

$$c = x$$

$$x = 180 - 116$$

$$x = 64 = c$$

$$a = 52^\circ \quad b = 52^\circ \quad c = 64^\circ$$

$$\begin{array}{r} 180 \\ - 116 \\ \hline 64 \end{array}$$



- (b) Find the size of each of the angles  $x$  and  $y$ .  
Hence give the special name for triangle  $LMN$ .

[3]

$$x + y + 52 = 180$$

$$y = 180 - 52 - 64$$

$$y = 64$$

$$x = 64^\circ$$

$$y = 64^\circ$$

The special name for triangle  $LMN$  is isosceles



9. (a) Reflect the triangle in the  $x$ -axis.  
Then translate the **reflected triangle** 5 squares left and 4 squares up. [2]

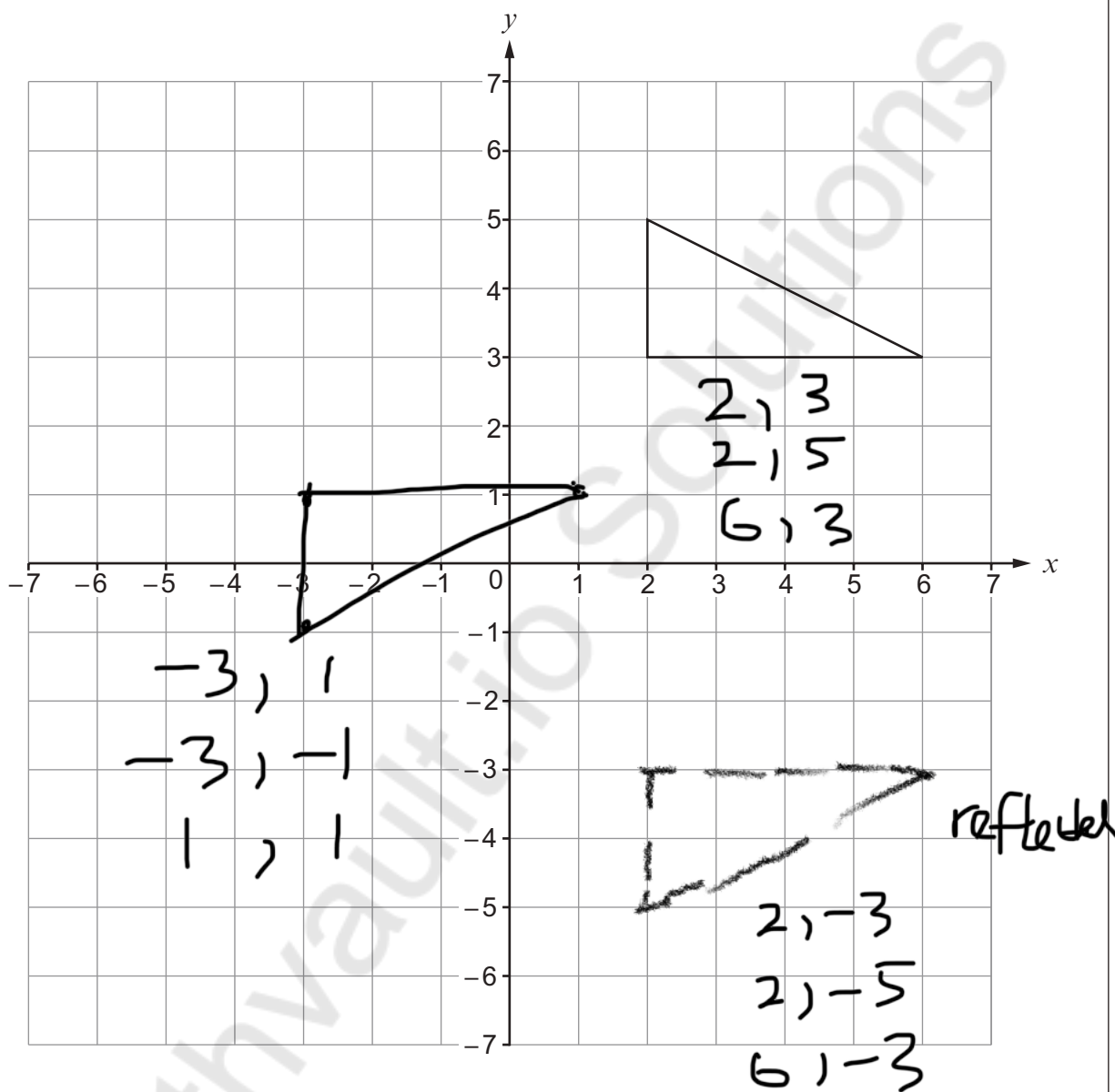

(b) The circle shown below is rotated  $90^\circ$  anticlockwise about the origin.

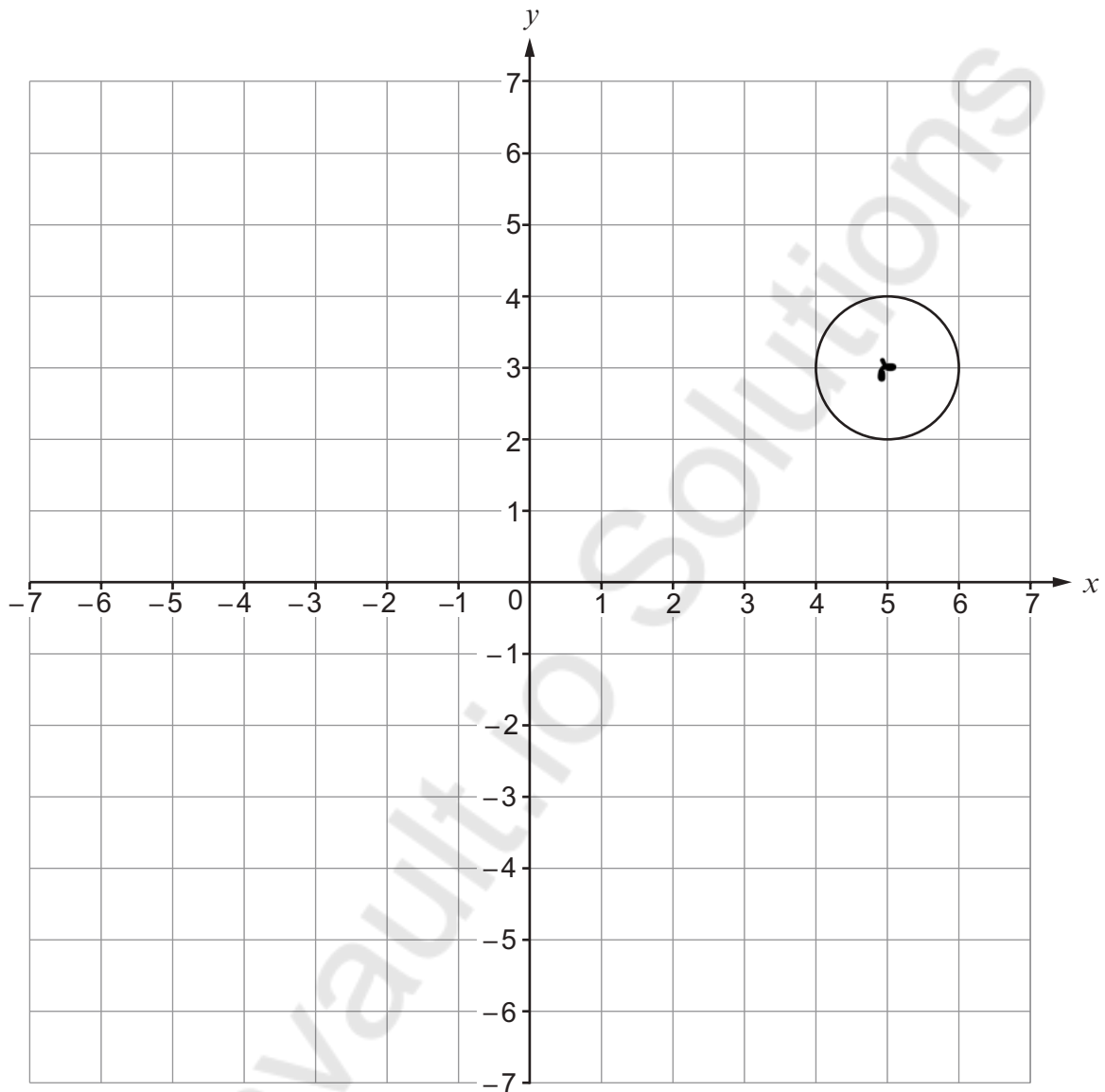

What are the coordinates of the centre of the circle at its new position?  
Circle the correct answer.

[1]

(3, -5)

(-5, -3)

(-3, -5)

(-3, 5)

(3, 5)



10. (a) Expand  $3x(x^2 - 2)$ .

[2]

$$3x \cdot x^2 - 3x \cdot 2$$

$$3x^3 - 6x$$

(b) Make  $g$  the subject of the formula  $f = 2 - 3g$ .

[2]

$$3g = 2 - f$$

$$g = \frac{2 - f}{3}$$

$$g = \frac{2}{3} - \frac{f}{3}$$

(c) (i) Solve  $7x - 3 < 29$ .

[2]

$$7x < 29 + 3$$

$$7x < 32$$

$$\frac{7x}{7} < \frac{32}{7}$$

$$x < 4\frac{4}{7}$$

(ii) What is the greatest integer value of  $x$  that satisfies the above inequality?

[1]

$$4 \text{ as } 4\frac{4}{7} \approx 4$$



11. Two straight lines,  $AB$  and  $AC$ , are shown below.

The point  $P$  is

- equidistant from line  $AB$  and line  $AC$ ,
- 6 cm from point  $B$ ,
- **more** than 10 cm from point  $A$ .

Show clearly the position of point  $P$ .

[3]

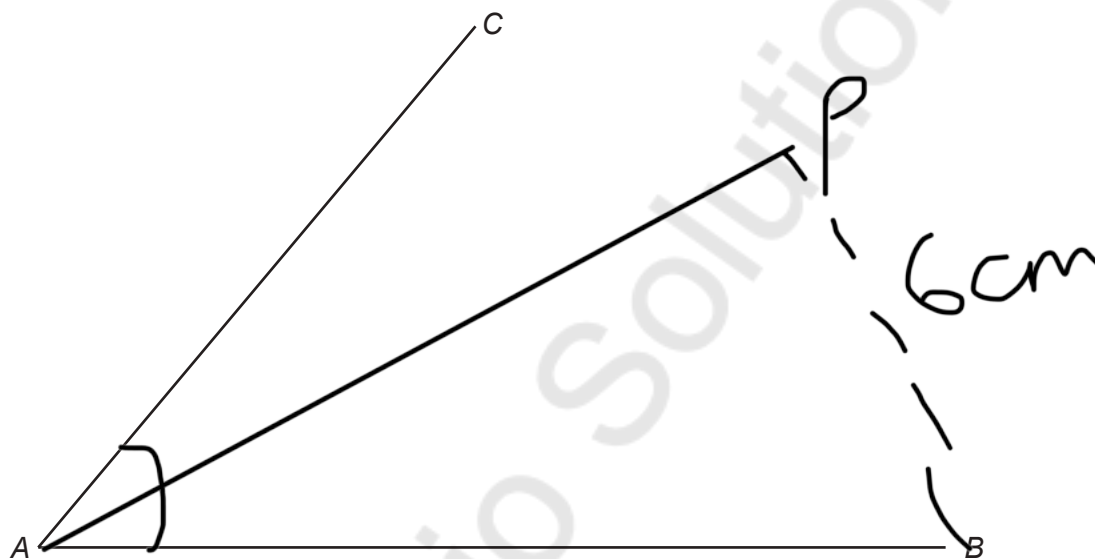

12. (a) Share £720 in the ratio 2 : 7.

[2]

$$2 + 7 = 9$$

$$\frac{2}{9} \times 720 = 160$$

$$\frac{7}{9} \times 720 = 560$$

$$£160 : £560$$

(b) Calculate the value of the reciprocal of 0.2.

[2]

$$\frac{1}{0.2} = \frac{1}{\frac{2}{10}} = 1 \div \frac{2}{10}$$

$$= 1 \times \frac{10}{2} = 5$$



13. The diagram below shows an empty cylinder, with radius 10 cm and height 20 cm.

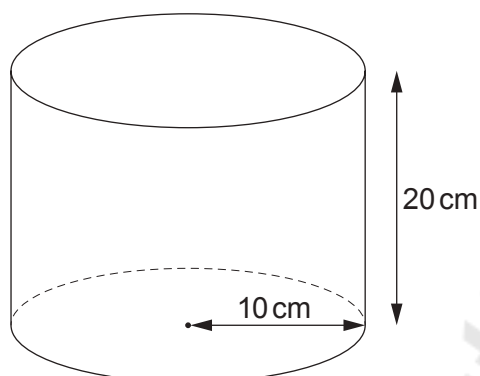

Diagram not drawn to scale

- (a) Using  $\pi = 3.14$ , calculate the volume of the cylinder. [2]

$$\begin{aligned}
 \text{Volume} &= \pi r^2 h \\
 &= 3.14 \times 10^2 \times 20 \\
 &= 3.14 \times 100 \times 20 \\
 &= 314 \times 20 \\
 &= 6280 \text{ cm}^3
 \end{aligned}$$

- (b) What is the greatest **whole** number of litres that this cylinder can hold? [1]

$$\begin{array}{r}
 6.280 \\
 \hline
 1000 \\
 \hline
 6
 \end{array}
 = 6.28 \text{ L} = 6 \text{ L}$$

..... litres



14. Five numbers are listed below.

3      3      6      13      15

Write down another set of five **positive whole** numbers such that

- all the numbers are **less than 20**,
- the median of the new set of numbers is greater than the median of the set shown above,
- the mean of the new set of numbers is less than the mean of the set shown above,
- the range of the new set of numbers is less than the range of the set shown above.

Your set of whole numbers must be written in the boxes.

[3]

Space for working:

$$\begin{aligned} \text{mean of given numbers} \\ &= 3 + 3 + 6 + 13 + 15 = \frac{40}{5} = 8 \\ \text{Range of given numbers} &= 15 - 3 \\ &= 12 \end{aligned}$$

$$\text{New set} = 2 \quad 2 \quad 7 \quad 12 \quad 13$$

$$\text{new mean} = \frac{36}{5}$$

$$\text{new range} = 13 - 2 = 11$$

My five positive whole numbers are

2

2

7

12

13



15. (a) Circle the correct answer for each of the following statements.

(i)  $(\sqrt{7})^4$  is equal to

 $\sqrt{28}$ 

28

 $\sqrt{14}$ 

14

49

$$(\sqrt{7})^4 = 7^2 = 49$$

[1]

(ii)  $12^0$  is equal to

0

1.2

12

120

$$12^0 = 1$$

[1]

(iii)  $\sqrt{3^2 \times 5^2}$  is equal to

 $35^2$  $15^2$ 

15

35

 $15^4$ 

$$\sqrt{3^2 \times 5^2} = \sqrt{9 \times 25} = \sqrt{225} = 15$$

[1]

(iv)  $3^{-4}$  is equal to

-12

 $\frac{1}{81}$ 

-81

 $\frac{1}{12}$  $\frac{3}{4}$ 

$$3^{-4} = \frac{1}{3^4} = \frac{1}{81}$$

[1]

(b)  $4 \times 2^{28}$  can be written as  $2^n$ .  
What is the value of  $n$ ?

[2]

$$4 \times 2^{28} = 2^2 \times 2^{28}$$

$$= 2^{(2+28)}$$

$$= 2^{30}$$

$$n = 30$$



16.  $A$ ,  $B$  and  $C$  are points on the circumference of a circle with centre  $O$ .

$$\widehat{ACB} = 74^\circ.$$

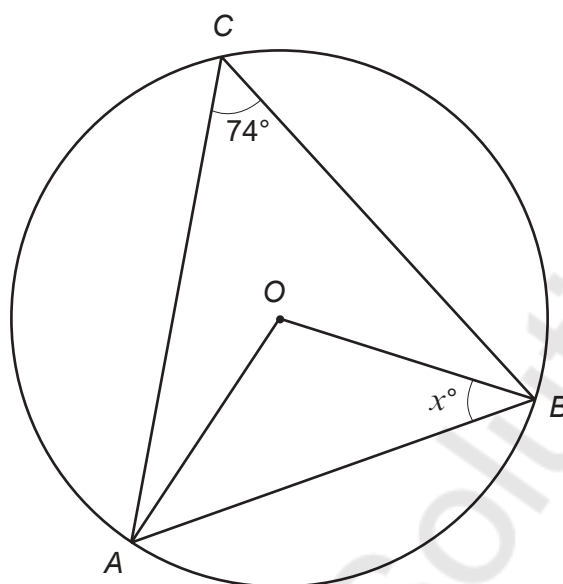

Diagram not drawn to scale

Calculate the value of  $x$ .

You must state any angle property of a circle that you use.

You must show all your working.

[4]

Angle subtended by an arc at the centre of a circle is 2x the angle subtended at the circumference

$$\therefore \angle AOB = 74 \times 2 = 148^\circ$$

$$x = \frac{180 - 148}{2} = \frac{32}{2} = 16^\circ$$



17. A biased six-sided dice is thrown a total of 1000 times. The graph shows the relative frequency of throwing a 'six' after 200, 400, 600, 800 and 1000 throws.

Relative frequency of throwing a 'six'

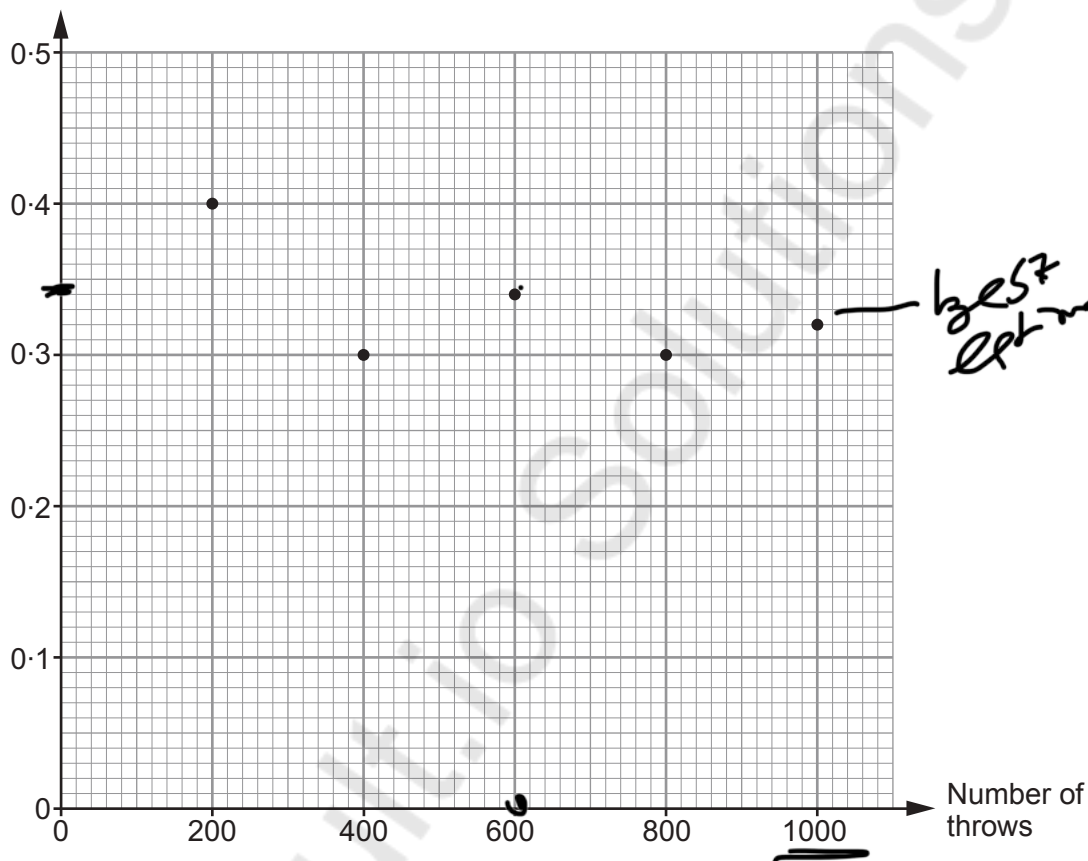

- (a) Which of the following is the best estimate for the probability of throwing a 'six' with this dice?  
Circle your answer. [1]

0.4

0.3

0.5

0.32

0.34

- (b) (i) How many 'sixes' were thrown in the first 600 throws of the dice? [2]

Ans = 204  $0.34 \times 600 = 204$

- (ii) How many **more** 'sixes' were recorded for these 600 throws than you would expect when a **fair** six-sided dice is thrown 600 times? [2]

$\frac{600}{6} = 100$   
 $204 - 100 = 104$



18. A cuboid has sides  $x$  cm, 5 cm and 7 cm.  
The total surface area of the cuboid is  $142 \text{ cm}^2$ .

Form an equation in terms of  $x$ .  
Solve the equation to find  $x$ .

[4]

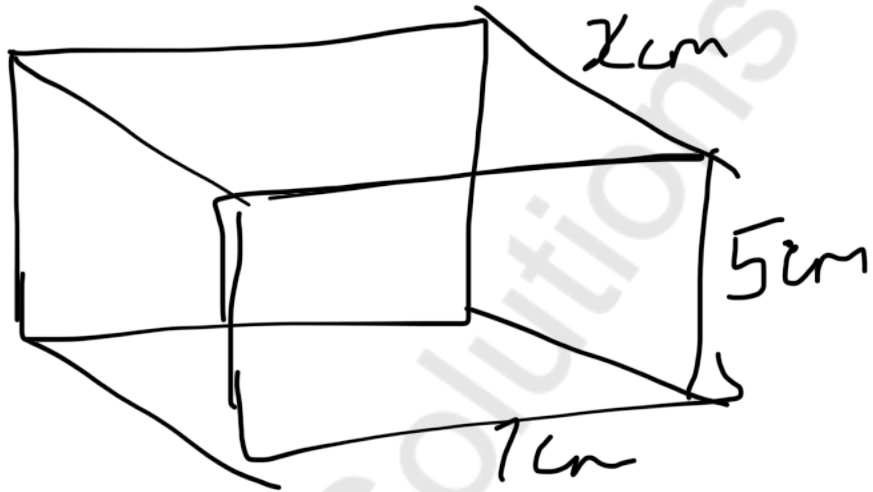

$$\text{Area of a cuboid} = 2(ab + bc + ca)$$

$$A = 2(7 \times 5 + 7x + 5x)$$

$$= 2(35 + 7x + 5x)$$

$$= 2(35 + 12x)$$

$$= 70 + 24x$$

$$24x = 142 - 70$$

$$x = \frac{72}{24} = 3$$

END OF PAPER

$$\begin{array}{r} 142 \\ - 70 \\ \hline 72 \end{array}$$

$$\underline{\underline{3}}$$



**BLANK PAGE**

**PLEASE DO NOT WRITE  
ON THIS PAGE**

Mathvaudio Solutions



Question number	Additional page, if required. Write the question number(s) in the left-hand margin.
	<p>Mathsvault.io Solutions</p>

Examiner only



**BLANK PAGE**

**PLEASE DO NOT WRITE  
ON THIS PAGE**

Mathvaudio Solutions

