

Surname	Centre Number	Candidate Number
First name(s)		0



GCSE

3300U10-1



TUESDAY, 24 MAY 2022 – MORNING

**MATHEMATICS
UNIT 1: NON-CALCULATOR
FOUNDATION TIER**

1 hour 25 minutes

ADDITIONAL MATERIALS

The use of a calculator is not permitted in this examination.
A ruler, a protractor and a pair of compasses may be required.

INSTRUCTIONS TO CANDIDATES

Use black ink or black ball-point pen. Do not use gel pen or correction fluid.

You may use a pencil for graphs and diagrams only.

Write your name, centre number and candidate number in the spaces at the top of this page.

Answer **all** the questions in the spaces provided.

If you run out of space, use the additional page at the back of the booklet. Question numbers must be given for all work written on the additional page.

Take π as 3.14.

INFORMATION FOR CANDIDATES

You should give details of your method of solution when appropriate.

Unless stated, diagrams are not drawn to scale.

Scale drawing solutions will not be acceptable where you are asked to calculate.

The number of marks is given in brackets at the end of each question or part-question.

In question **6**, the assessment will take into account the quality of your linguistic and mathematical accuracy in writing.

In question **10**, the assessment will take into account the quality of your organisation and communication.

For Examiner's use only		
Question	Maximum Mark	Mark Awarded
1.	5	
2.	2	
3.	1	
4.	2	
5.	2	
6.	3	
7.	4	
8.	3	
9.	2	
10.	5	
11.	3	
12.	4	
13.	3	
14.	4	
15.	4	
16.	3	
17.	3	
18.	4	
19.	3	
Total	60	



JUN223300U10101

Formula List – Foundation Tier

$$\text{Area of trapezium} = \frac{1}{2}(a + b)h$$

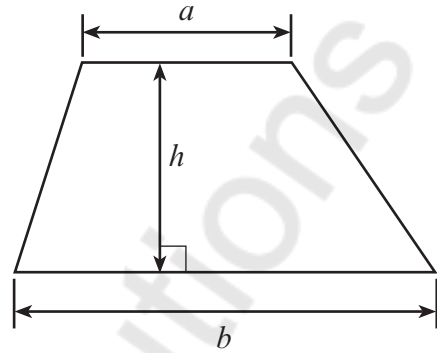

1. (a) Write 2376 correct to the nearest ten. [1]

2380

- (b) Add 643 and 8972. [1]

$$\begin{array}{r} 18972 \\ + 643 \\ \hline 9615 = 9615 \end{array}$$

- (c) Calculate one fifth of 335. [1]

$$\frac{1}{5} \times 335 = 67$$

- (d) Subtract 516 from 894. [1]

$$\begin{array}{r} 894 \\ - 516 \\ \hline 378 = 378 // \end{array}$$

- (e) Using all of the following digits, write down the smallest possible 4-digit number. [1]

7, 1, 5, 2

1257



2. (a) Tim chooses one letter at random from the word TOMATO.

Describe the chance that Tim chooses the letter T.
Circle the correct expression from those given below.

[1]

impossible

unlikely

an even chance

likely

certain

- (b) Megan chooses one letter at random from the word BANANA.

Describe the chance that Megan chooses the letter A.
Circle the correct expression from those given below.

[1]

impossible

unlikely

an even chance

likely

certain

3. Shade the smallest number of squares to make MN a line of symmetry.

[1]

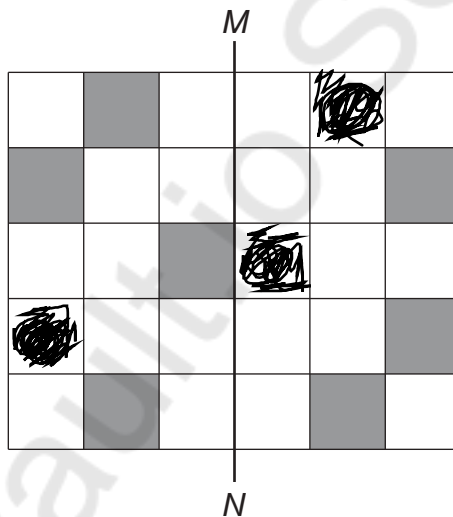

4. (a) Measure and write down the size of angle x .

[1]

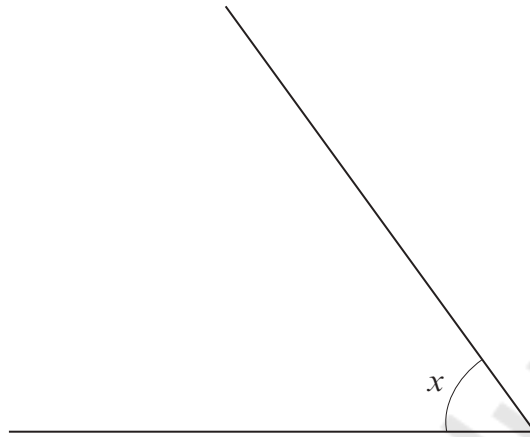

$$x = 54^\circ$$

- (b)

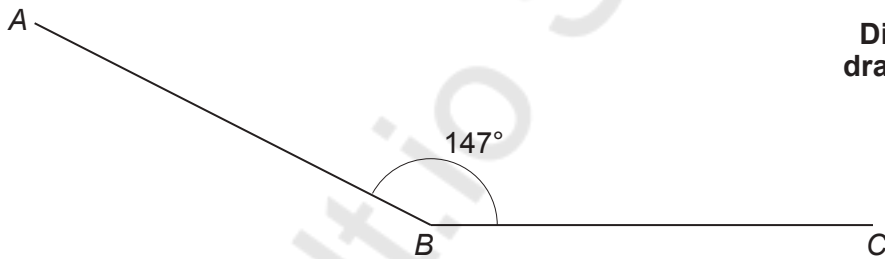
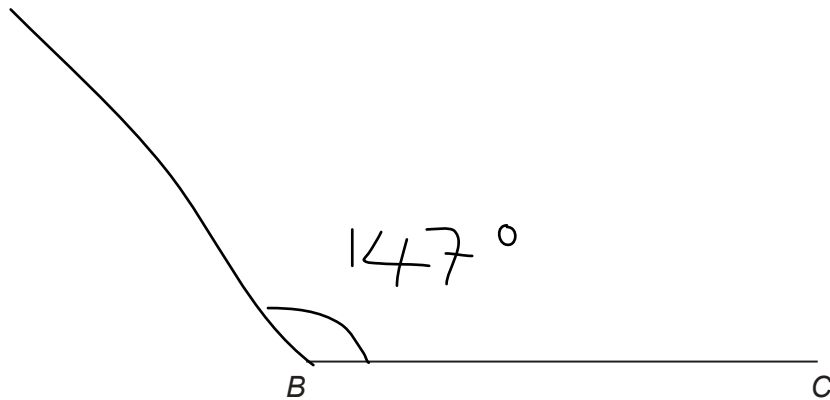

Diagram not
drawn to scale

In the space below, draw $\hat{A}BC = 147^\circ$ accurately.

The line BC has been drawn for you.

[1]



5. (a) How much time has passed between 8:30 a.m. and 2:15 p.m. on the same day? [1]

8:30 am to 2:15 pm
=> 5 hours 45 mins

- (b) Shade $\frac{2}{3}$ of the shape below. [1]

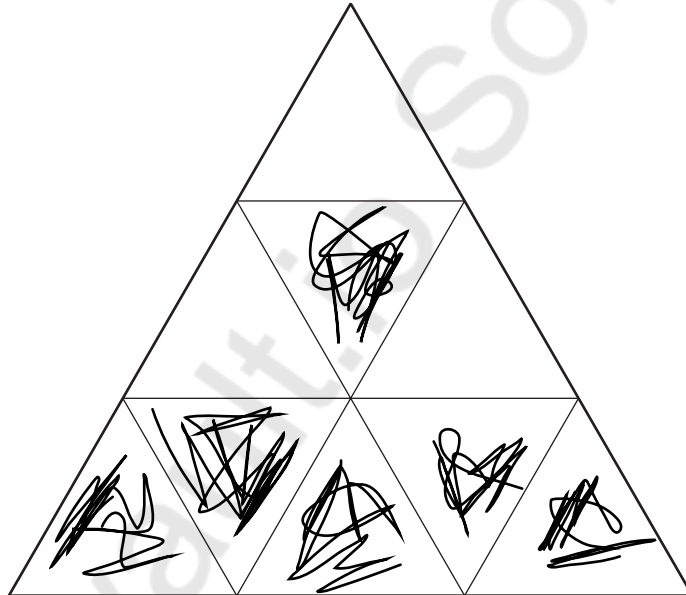

6. In this question, you will be assessed on the quality of your accuracy in writing.

Two identical small circles fit in a larger circle, as shown below.
 AB is a straight line passing through the centres of all three circles.
 The radius of each of the small circles is 7.5 cm.

Calculate the length of the diameter of the large circle.
 You must show all your working.

[2 + 1 W]

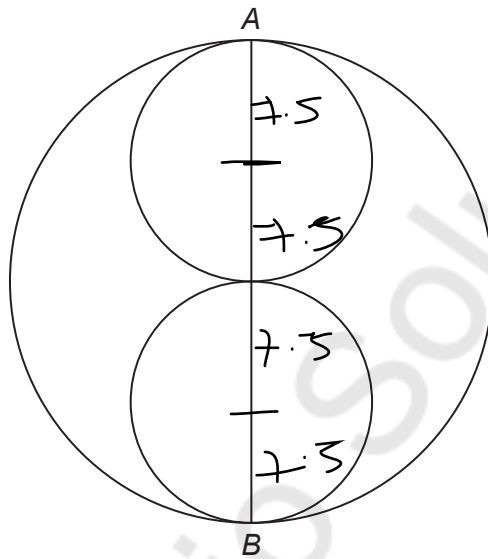

$$r = \frac{d}{2}$$

Diagram not
drawn to scale

$$4 \times 7.5 \text{ cm} = 30 \text{ cm}$$



7. (a) Simplify $12a - 19a + 10a$.

[1]

$$12a + 10a - 19a$$

$$\Rightarrow 22a - 19a = 3a$$

- (b) Solve the following equations.

(i) $3y = 189$

[1]

$$y = 189 \div 3$$

$$= 63$$

(ii) $27 - x = 15$

[1]

$$x = 27 - 15$$

$$x = 12 //$$

- (c) Write down the value of $\sqrt{36}$.

[1]

6

8. A sack contains 5.4 kg of potatoes.
A second sack contains 3.08 kg of potatoes.
A third sack contains 2.2 lb (**pounds**) of potatoes.

Calculate the total mass of these potatoes.
Give your answer in **kilograms**.

[3]

$$2.2 \text{ lb} = 1 \text{ kg}$$

$$\Rightarrow 5.4 + 3.08 + 1 = 9.48 \text{ kg}$$



9. Complete the diagram so that the grid has rotational symmetry of order 4 about the centre, ●. You must shade as few squares as possible. [2]

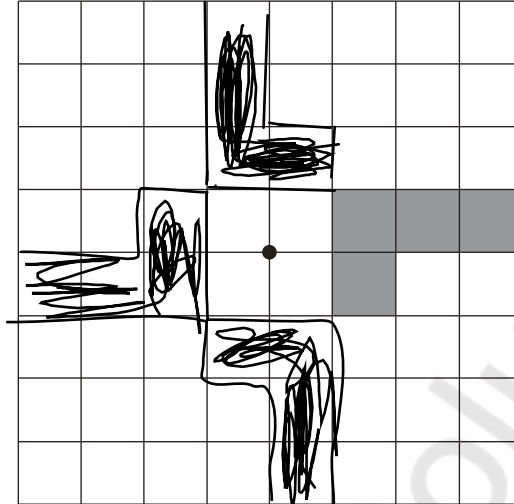

10. In this question, you will be assessed on the quality of your organisation and communication.

A bucket can hold 4000 ml of water.

A jug can hold 2.5 litres of water.

An empty tank has a capacity of 17 litres.

The tank is filled to the top using a combination of full buckets and full jugs of water.

How many full buckets and full jugs must be used to fill the tank exactly?

You must show all your working.

[4 + 1 OC]

$$4B + 2.5J = 17$$

$$\text{If } B=1 : 4(1) + 2.5J = 17 : J = 5.2$$

$$B=2 : 4(2) + 2.5J = 17 : J = 3.6$$

$$B=3 : 4(3) + 2.5J = 17$$

$$12 + 2.5J = 17$$

$$J = 5 - 2.5$$

$$J = 2$$

$$4(3) + 2.5(2) \Rightarrow 17$$

Number of full buckets 3

Number of full jugs 2



11. Raji chooses one number at random from this list of numbers.

2, 4, 6, 8, 10, 12, 14, 16, 18, 20

On the probability scale below, mark the points A, B and C where:

- A is the probability of Raji choosing an even number
- B is the probability of Raji choosing a number greater than 8
- C is the probability of Raji choosing a square number.

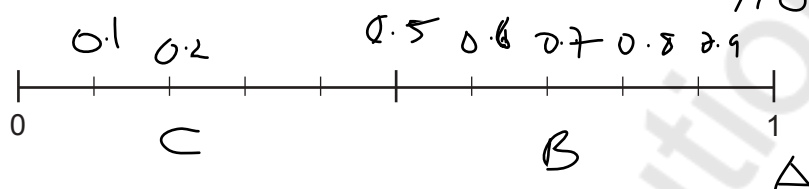

[3]



12. Calculate each of the following.

(a) $3^2 \times 2^3$

[2]

$$3 \times 3 \times 2 \times 2 \times 2$$

$$\Rightarrow 72$$

(b) $-124 \div 4$

[1]

$$-124 \div 4 \Rightarrow -31$$

(c) 15% of 280

[1]

$$\frac{15}{100} \times \frac{280}{1} = 1.5 \times 28$$

$$\Rightarrow 42 //$$

13. Write 0.3 , $\frac{8}{25}$ and 31% in ascending order.

You must show all your working.

[3]

$$\rightarrow \frac{30}{100}, \frac{32}{100}, \frac{31}{100}$$

$$\rightarrow \frac{30}{100}, \frac{31}{100}, \frac{32}{100}$$

0.3

Smallest value

31%

$\frac{8}{25}$

Greatest value

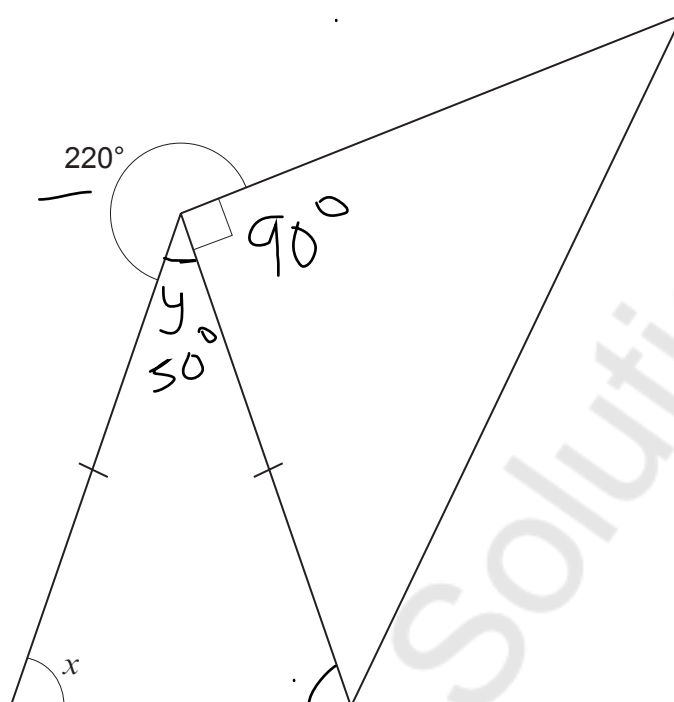

14.

Diagram not
drawn to scale

Calculate the size of angle x .
You must show all your working.

[4]

$$360 - 90 - 220 = 50^\circ$$

$$x = 180 - 50 = 130 \div 2 \\ = 65^\circ$$

$$x = \dots\dots\dots^\circ$$



15. (a) Find a whole number value of n , so that $7n-9$ is a multiple of 4.
You must show all your working. [2]

$$7n - 9 : n = 1 \rightarrow -2, n = 2 \rightarrow 5, n = 3 \rightarrow 12$$

When $n = 12$, $7n-9$ is a multiple of 4.

- (b) Find a whole number value of n , so that $3n-5$ is a prime number.
You must show all your working. [2]

$$3n - 5$$

$$n = 1 \rightarrow 3 - 5 = -2$$

$$n = 2 \rightarrow 6 - 5 = 1$$

$$n = 3 \rightarrow 9 - 5 = 4$$

$$n = 4 \rightarrow 12 - 5 = 7$$

When $n = 4$, $3n-5$ is a prime number.



16. (a) A bag contains red balls, green balls and yellow balls.
The number of green balls is equal to the number of yellow balls.

Mali picks one ball from the bag at random.
The probability that she will pick a red ball is 0.3.

Find the probability that Mali will pick a yellow ball.

[2]

$$1 - 0.3 = 0.7$$

$$P(\text{green}) = 0.7$$

$$P(\text{yellow}) = 0.7 \div 2 \rightarrow 0.35$$

- (b) A different bag contains 10 balls.
Some of the balls in the bag are blue.
All the other balls are white.
Morgan picks a ball from the bag at random.
He says,

The probability that I will pick a blue ball from
the bag is 0.25.

Explain why Morgan cannot be correct.

[1]

10 balls: Probability = 0.1, 0.2, 0.3



17. Solve the following equation.

[3]

$$8x - 38 = 17 - 3x$$

$$8x + 3x = 17 + 38$$

$$11x = 55$$

$$x = \frac{55}{11} = 5 //$$



18. A rectangle and a trapezium are shown below.

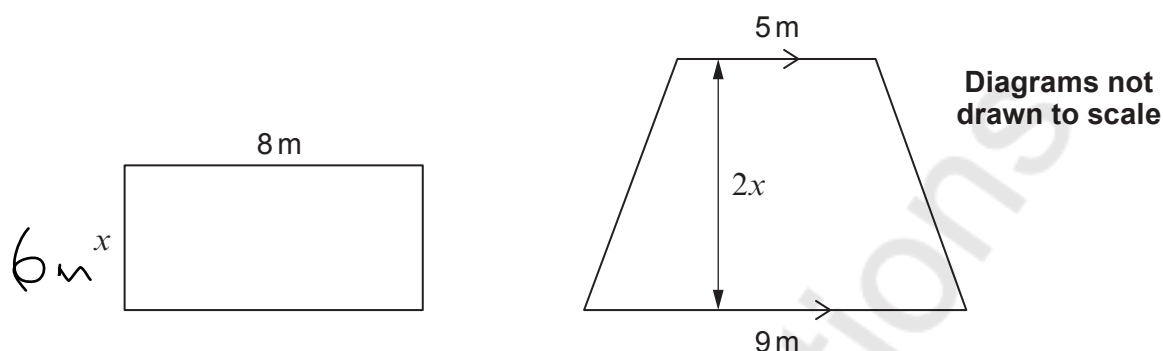

The area of the rectangle = 48 m^2 .

The width of the rectangle is represented by x .

The height of the trapezium is twice the width of the rectangle.

Calculate the area of the trapezium.

You must show all your working.

[4]

$$48 = 8x$$

$$x = 48 \div 8 = 6 \text{ m}$$

Trapezium

$$h = 6 \times 2 = 12 \text{ m}$$

$$A = \frac{(5+9) \times (6 \times 2)}{2}$$

$$\Rightarrow 84 \text{ m}^2$$



19. Write down four whole numbers so that:

- they are all between 1 and 15 inclusive
- they have a mode of 7
- they have a median value of 8.5
- their mean is 9.

Write your numbers in the boxes below.

[3]

7, 7, 10, 12

7	7	10	12
---	---	----	----

END OF PAPER



BLANK PAGE

**PLEASE DO NOT WRITE
ON THIS PAGE**

Mathvaudio Solutions



BLANK PAGE

**PLEASE DO NOT WRITE
ON THIS PAGE**

Mathvaudio Solutions

