

Surname	Centre Number	Candidate Number
First name(s)		0



GCSE

3300U40-1



WEDNESDAY, 13 NOVEMBER 2024 – MORNING

**MATHEMATICS
UNIT 2: CALCULATOR-ALLOWED
INTERMEDIATE TIER**

1 hour 45 minutes

ADDITIONAL MATERIALS

A calculator will be required for this examination.
A ruler, protractor and a pair of compasses may be required.

INSTRUCTIONS TO CANDIDATES

Use black ink or black ball-point pen. Do not use gel pen or correction fluid.
You may use a pencil for graphs and diagrams only.
Write your name, centre number and candidate number in the spaces at the top of this page.
Answer **all** questions.
Write your answers in the spaces provided in this booklet. If you run out of space, use the additional page(s) at the back of the booklet, taking care to number the question(s) correctly.
Take π as 3.14 or use the π button on your calculator.

INFORMATION FOR CANDIDATES

You should give details of your method of solution when appropriate.
Unless stated, diagrams are not drawn to scale.
Scale drawing solutions will not be acceptable where you are asked to calculate.
The number of marks is given in brackets at the end of each question or part-question.
In question 2, the assessment will take into account the quality of your linguistic and mathematical organisation, communication and accuracy in writing.

For Examiner's use only		
Question	Maximum Mark	Mark Awarded
1.	5	
2.	6	
3.	4	
4.	3	
5.	4	
6.	9	
7.	2	
8.	4	
9.	4	
10.	5	
11.	4	
12.	3	
13.	3	
14.	6	
15.	4	
16.	5	
17.	5	
18.	4	
Total	80	

3300U401
01



NOV243300U40101

Formula List – Intermediate Tier

Area of trapezium = $\frac{1}{2}(a + b)h$

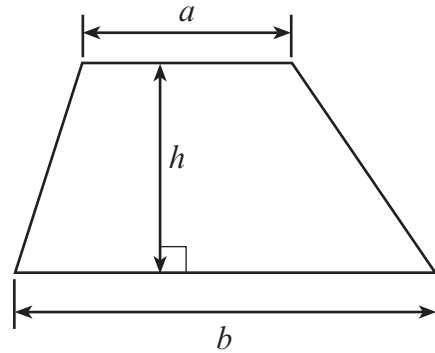

Volume of prism = area of cross-section \times length

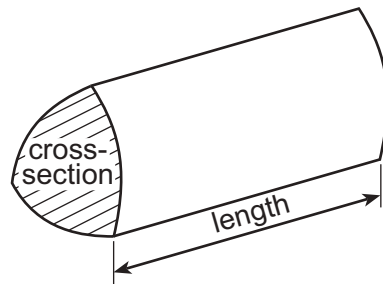

1. (a) Calculate the size of angle x .

[2]

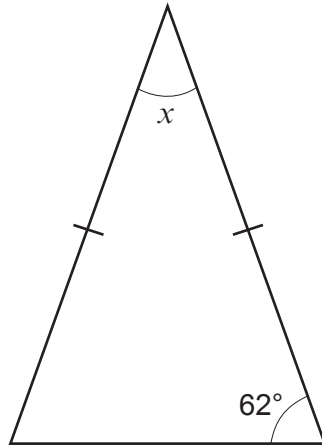

Diagram not drawn to scale

.....

.....

.....

.....

.....

$x = \text{.....}^\circ$



- (b) $PQRS$ is a quadrilateral.
 QRT is a straight line.
Calculate the size of angle y .

[3]

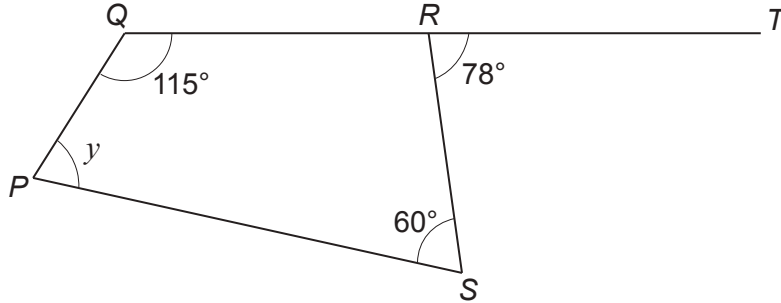

Diagram not drawn to scale

.....

.....

.....

.....

.....

$y = \text{.....}^\circ$



3. (a) Calculate the following.

$$\frac{17}{50} \text{ of } 24.5 + 78\% \text{ of } 103.5$$

You must show all your working.

[2]

.....

.....

.....

.....

.....

- (b) Express £19.44 as a percentage of £36.

[2]

.....

.....

.....

.....

.....

4. Shade the least number of squares so that the grid has rotational symmetry of order 2. [3]

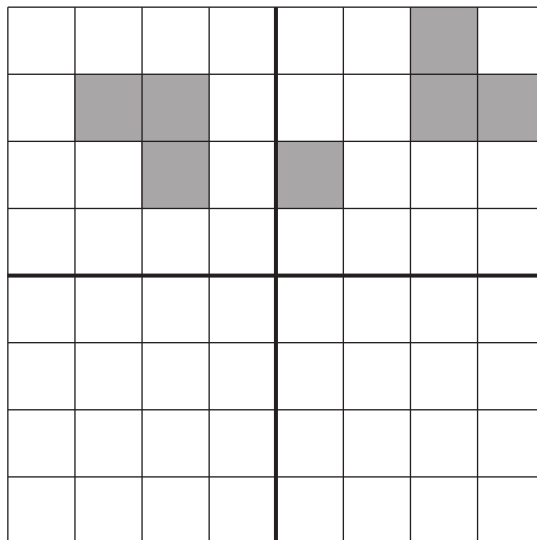

5. Megan has the following 7 playing cards.

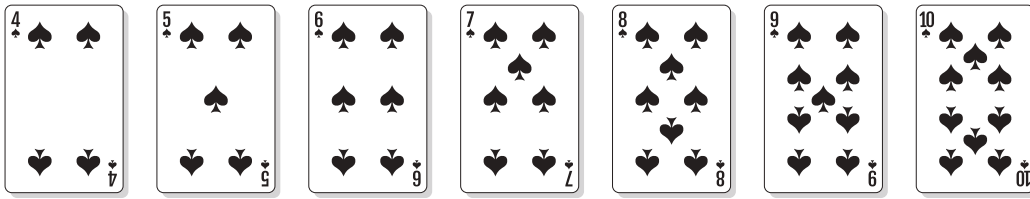

She turned these cards face down.

Megan then chose a card at random and recorded the number.

- (a) What is the probability that Megan recorded the number 5?
Circle your answer.

[1]

$$\frac{5}{7}$$

$$\frac{1}{7}$$

1

5

$$\frac{7}{5}$$

- (b) (i) What is the probability that Megan recorded a square number?
Circle your answer.

[1]

$$\frac{2}{5}$$

$$\frac{1}{7}$$

$$\frac{2}{7}$$

$$\frac{4}{7}$$

$$\frac{4}{5}$$

- (ii) Megan chooses a card at random 91 times.
How many times would you expect Megan to record a square number?
You must show all your working.

[2]



6. (a) Solve each of the following equations.

(i) $3y - 5 = 19$

[2]

.....

.....

.....

.....

(ii) $7(2t + 3) = 56$

[3]

.....

.....

.....

.....

(iii) $8p + 5 = 3p - 25$

[3]

.....

.....

.....

.....

(b) Factorise $w^2 - 6w$.

[1]

.....

.....

.....

.....



7. A bag contains 1 yellow counter and 2 pink counters.
Olga puts more yellow counters into the bag.

She takes one counter out of the bag at random.

The probability of taking a yellow counter out of the bag is $\frac{3}{4}$.

How many **more** yellow counters did Olga put into the bag? [2]

.....

.....

.....

.....

.....

.....

.....

.....

.....

.....

.....

.....

.....

.....

.....

.....

.....

.....

.....

.....

.....

.....

Olga put more yellow counters into the bag



8. (a) Rotate the triangle through 90° clockwise, about the origin.

[2]

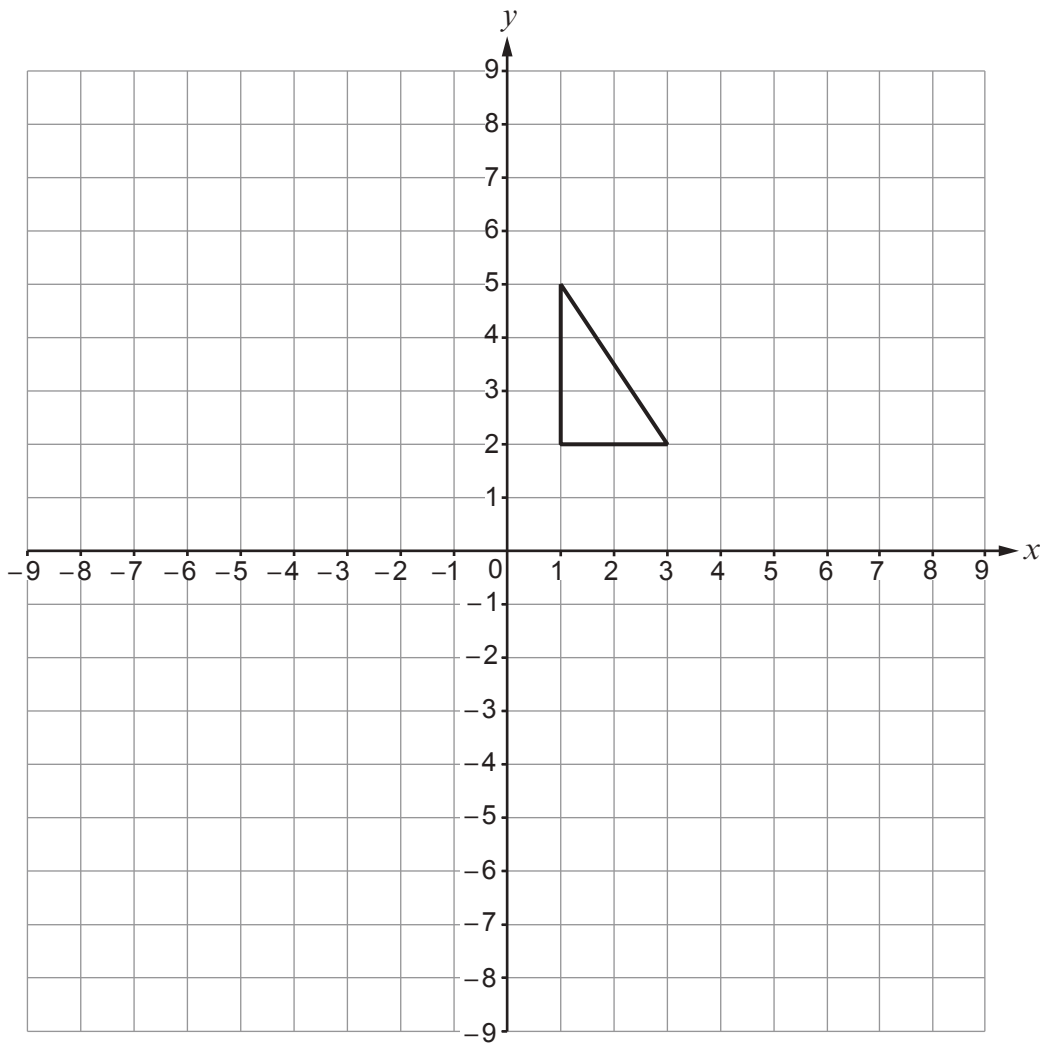

(b) Reflect the triangle in the line $x = -2$.

[2]

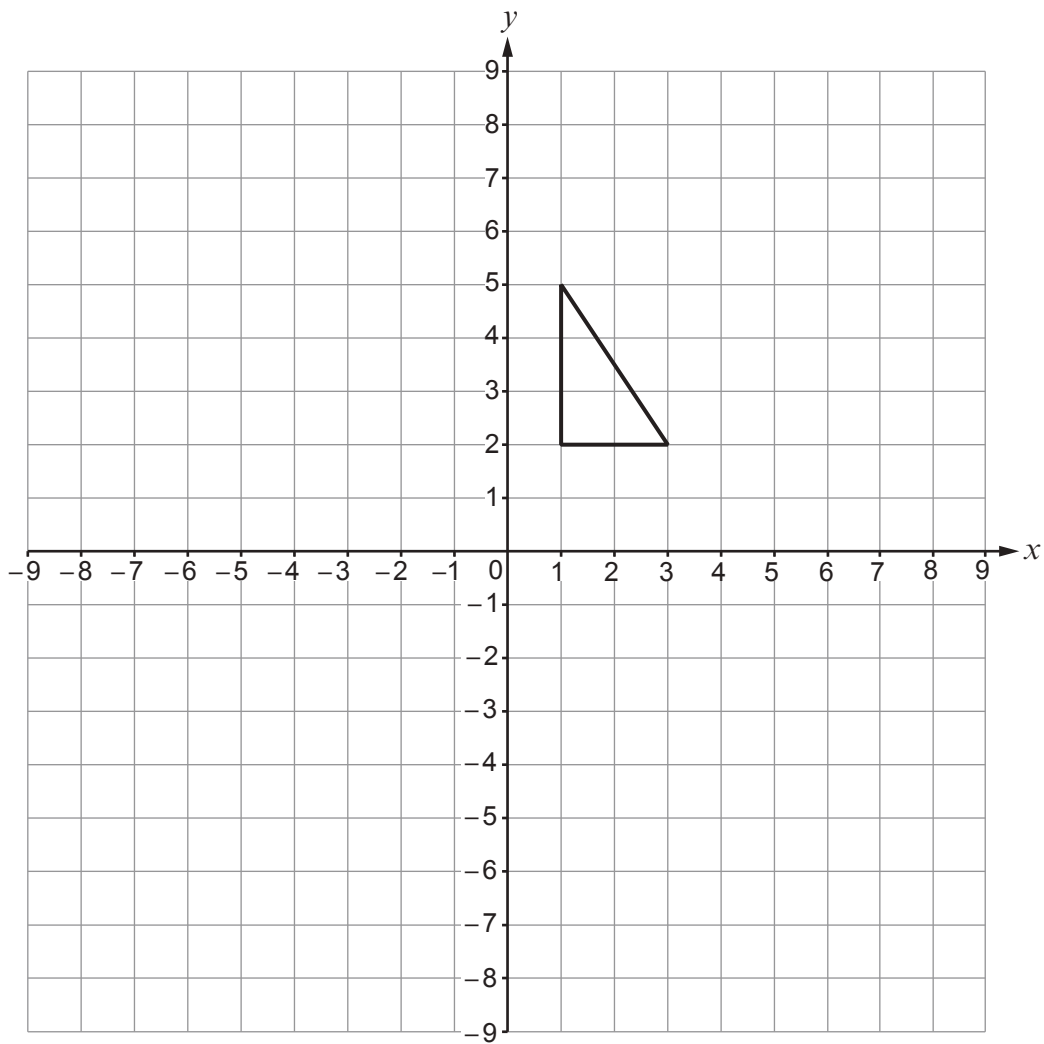

9. Display the following information in the Venn diagram below.

[4]

- Universal Set $\mathcal{E} = \{\text{Integers between 1 and 7 inclusive}\}$
- Set A = {even numbers}
- Set B = {factors of 6}
- Set C = {prime numbers}

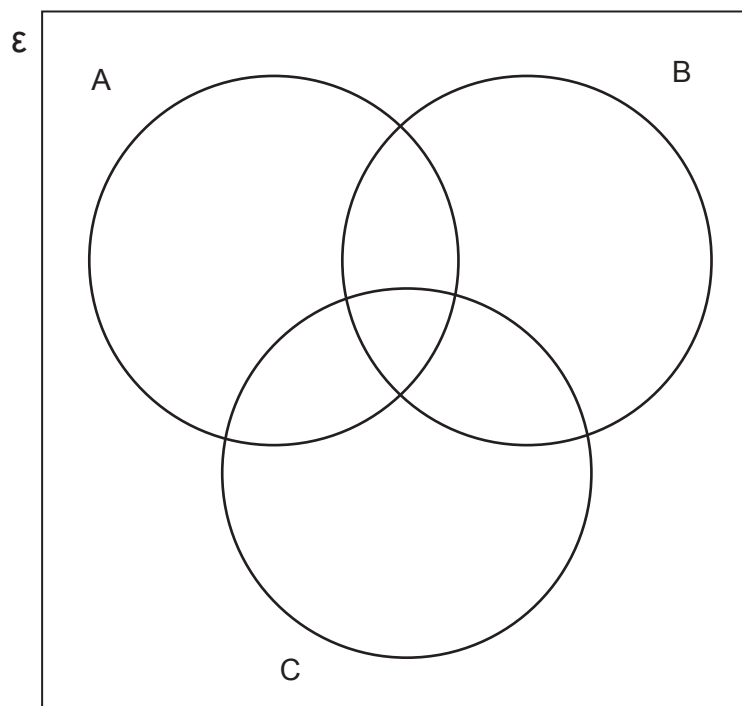

.....

.....

.....

.....

.....

.....

.....

.....

.....



12. Find five numbers so that:

- their mean is 4.5
- their mode is 3.5.

Write your five numbers in the boxes below.

[3]

.....

.....

.....

.....

.....

.....

.....

.....

.....

.....

.....

.....

.....

.....

.....

.....

.....

.....

.....

.....

.....

.....

.....

The five numbers are

13. The interior angle of a regular polygon is 171° .

How many sides does the polygon have?

[3]

.....

.....

.....

.....

.....

.....

.....

.....

.....

.....

.....

.....

.....

.....

.....

.....

.....

.....

.....

.....

.....

.....



14. (a) Calculate the length of AC.

[3]

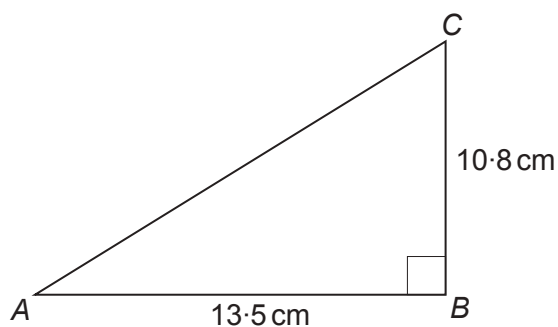

Diagram not drawn to scale

.....

.....

.....

.....

.....

.....

- (b) Calculate the value of x .

[3]

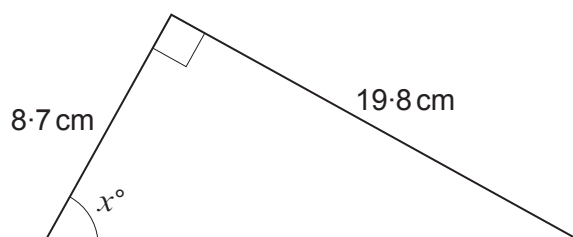

Diagram not drawn to scale

.....

.....

.....

.....

.....

.....



15. Line AB is drawn below.
Point C lies **below** the line AB .
The region in which point C is located is such that:

- $\hat{ABC} \leq 30^\circ$
- line $BC \leq 5$ cm.

Use a ruler and a pair of compasses to **construct** suitable arcs and lines to show this region.
You must show your construction arcs.
Shade the region in which point C is located. [4]

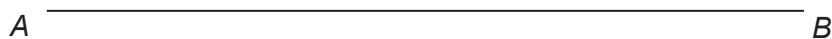

16. PowrUp is a company that makes batteries. The quality of the batteries is tested regularly. PowrUp calculates the relative frequency of faulty batteries after checking a total of 1000, 2000, 3000, 4000 and 5000 batteries. The results are plotted on the graph below.

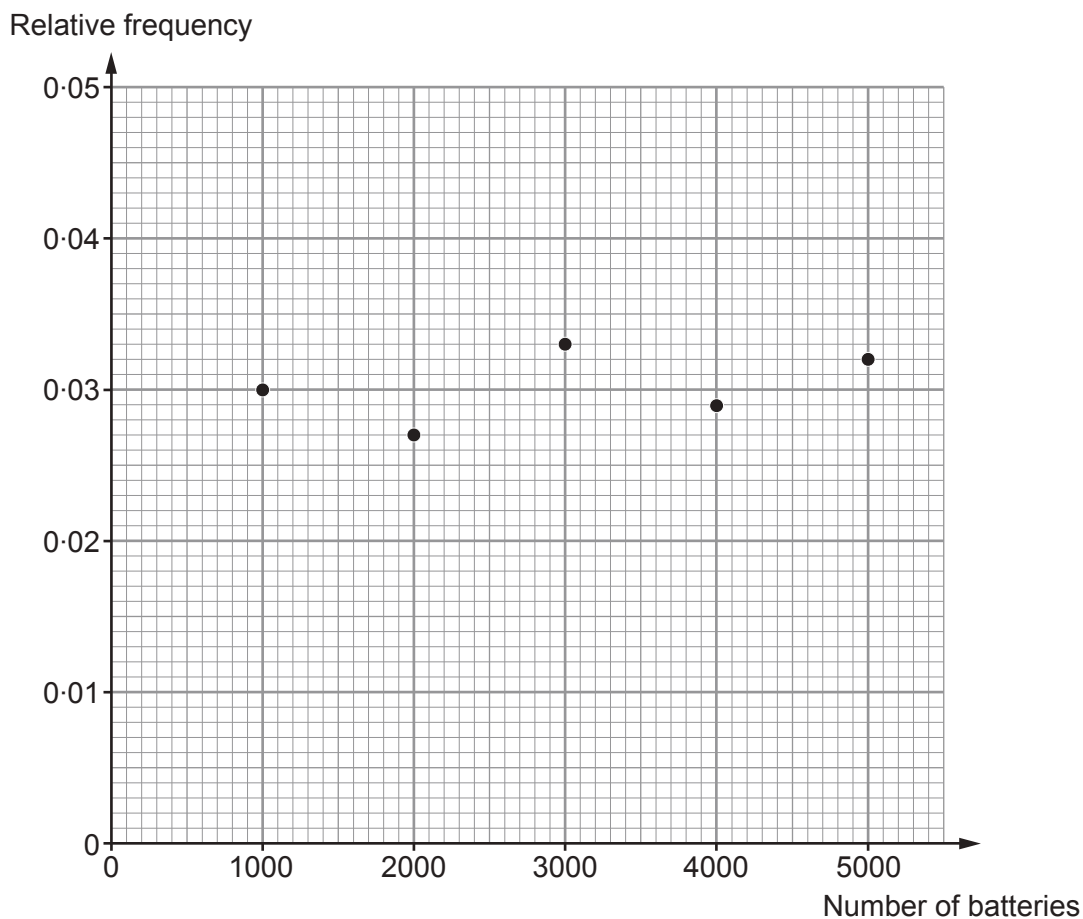

- (a) One battery is selected at random. Write down the best estimate for the probability that this battery will be faulty. You must give a reason for your choice. [2]

.....

Probability =

Reason:

.....

.....

.....

.....



17. The diagram shows a **solid** cylinder with radius 10 cm.
The total **surface area** of the solid cylinder is 1570.8 cm^2 .

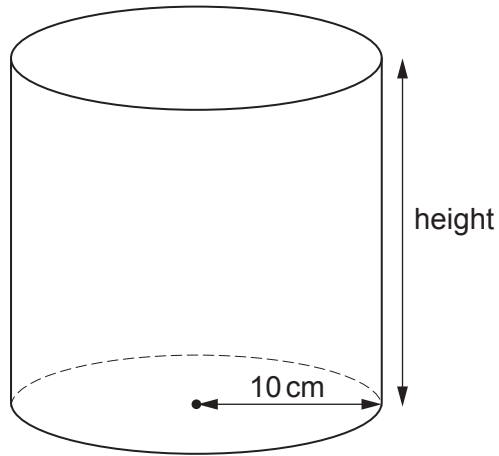

Diagram not drawn to scale

Find the height of the cylinder.

[5]

.....

.....

.....

.....

.....

.....

.....

.....

.....

.....

.....

.....

.....

.....

.....

.....

.....

.....

.....

.....



BLANK PAGE

**PLEASE DO NOT WRITE
ON THIS PAGE**



BLANK PAGE

**PLEASE DO NOT WRITE
ON THIS PAGE**

